



7th ICENIS

INTERNATIONAL CONFERENCE ON ENERGY, ENVIRONMENT, EPIDEMIOLOGY AND INFORMATION SYSTEM (ICENIS 2022)



Semarang

August 9th – 10th, 2022

www.icenis.undip.ac.id



School of Postgraduate Studies Diponegoro University

Imam Bardjo Street No 5, Pleburan, Semarang 50241

www.pasca.undip.ac.id

PREFACE

The 7th International Conference on Energy, Environment, Epidemiology and Information System (ICENIS) 2022 is an annual conference organized by the School of Postgraduate Studies Diponegoro University. The theme of this conference is “Reconciliation of energy, environment, health, and digital information after the Covid-19 pandemic for global prosperity”. In this year's conference, the implementation was carried out through an online meeting because it was still in a pandemic atmosphere. This conference is expected to designate an interactive international forum to provide a platform for sharing and exchanging information on the latest research on energy, environment, epidemiology, and information system.

Our technical program is rich and varied with 7 keynote speakers that come from 5 continents: America (Columbia, Canada), Australia, Asia (Indonesia, Malaysia), and Europe (Switzerland, Nederland). There are 227 technical papers split between 14 parallel oral sessions each day. The participants come from various countries and from all over Indonesia consisting of researchers, lecturers, practitioners, and post and undergraduate students belonging to various institutions. A large number of papers submitted to this conference indicate that the interest in the field of energy, environment, epidemiology, and information system gains continuous rise in this country and worldwide.

We are also proud to present the plenary speakers who are qualified to share their valuable information and knowledge at this conference. On behalf of the ICENIS 2022 Committee, we wish all participants to have good attainment. We would like to acknowledge our high appreciation to the Rector of Diponegoro University, the Dean School of Postgraduate Studies Diponegoro University, and the keynote speakers. We would also like to take this opportunity to thank the organizing team from the School of Postgraduate Studies, Diponegoro University for all their hard work and dedication in preparing for this conference. As we have tried our best in conducting this event, we humbly realize that we may still be lacking in some parts. Accordingly, we would like to apologize for any inconvenience.

Thank you.

The Editors
Dr. Budi Warsito
Dr. Dwi Sutiningsih
Dr. Oky Dwi Nurhayati

Statement of Peer review

In submitting conference proceedings to *Web of Conferences*, the editors of the proceedings certify to the Publisher that

1. They adhere to its **Policy on Publishing Integrity** in order to safeguard good scientific practice in publishing.
2. All articles have been subjected to peer review administered by the proceedings editors.
3. Reviews have been conducted by expert referees, who have been requested to provide unbiased and constructive comments aimed, whenever possible, at improving the work.
4. Proceedings editors have taken all reasonable steps to ensure the quality of the materials they publish and their decision to accept or reject a paper for publication has been based only on the merits of the work and the relevance to the journal.

Title, date and place of the conference

**7th International Conference on Energy, Environment, Epidemiology and Information System (ICENIS)
9-10 August 2022, Semarang Indonesia**

Proceedings editor(s):

18.10.2022

18.10.2022

19.10.2022

Dr. Budi Warsito

Dr. Dwi Sutiningsih

Dr. Fuad Muhammad

Date and editor's signature

[All issues](#) ▶ Volume 359 (2022)[◀ Previous issue](#)[Table of Contents](#)[Next issue ▶](#)

Free Access to the whole issue

E3S Web of Conferences

Volume 359 (2022)

The 7th International Conference on Energy, Environment, Epidemiology and Information System (ICENIS 2022)

Semarang, Indonesia, August 9-10, 2022

B. Warsito, D. Sutiningsih and F. Muhammad (Eds.)

Export the citation of the selected articles [Export](#)

[Select all](#)

[Open Access](#)

About the conference

Published online: 31 October 2022

PDF (427 KB)

[Open Access](#)

Statement of Peer review

Published online: 31 October 2022

PDF (81.3 KB)

- ∨ Energy
- ∨ Culture and Environmental Management
- ∨ Language and Environment
- ∨ History and Environment
- ∨ Information System Management and Environment
- ∨ Social Environment

- Energy

- [Open Access](#)
Energy Planning in West Java using Software LEAP (Long-range Energy Alternatives Planning) 01001
Dindin Syarief Nurwahyudin, Nanik Trihastuti and Nuki Agya Utama
Published online: 31 October 2022
DOI: <https://doi.org/10.1051/e3sconf/202235901001>
PDF (2.676 MB) | [References](#) | [NASA ADS Abstract Service](#)
-
- [Open Access](#)
An Effect of Photovoltaic (PV) Arrangement on Performance of Small-scale Solar Energy System 01002
Sudarsono Sudarsono, Toto Rusianto and Samuel Kristiyama
Published online: 31 October 2022
DOI: <https://doi.org/10.1051/e3sconf/202235901002>
PDF (1.863 MB) | [References](#) | [NASA ADS Abstract Service](#)
-
- [Open Access](#)
Screw Turbine in In-pipe Hydroelectric Power Generation 01003
Rizki Nurilyas Ahmad, Dimas Lugia Hardianto, Abimanyu Abimanyu and Laili Etika Rahmawati
Published online: 31 October 2022
DOI: <https://doi.org/10.1051/e3sconf/202235901003>
PDF (1.894 MB) | [References](#) | [NASA ADS Abstract Service](#)
-
- [Open Access](#)
Improvement the Capacity of Electrical Energy in Residential Using PV With On-Grid System 01004
Adhi Kusmantoro and Irna Farikhah
Published online: 31 October 2022
DOI: <https://doi.org/10.1051/e3sconf/202235901004>
PDF (2.178 MB) | [References](#) | [NASA ADS Abstract Service](#)
-
- [Open Access](#)

Small-Scale Renewable Energy Technology to Support the Sustainability of a Food Security Village in Malang City 01005

Laksni Sedyowati, Sari Yuniarti and Sufiyanto Sufiyanto

Published online: 31 October 2022

DOI: <https://doi.org/10.1051/e3sconf/202235901005>

[PDF \(2.109 MB\)](#) | [References](#) | [NASA ADS Abstract Service](#)

[Open Access](#)

Power Flow and Protection Analysis of 20kV System as Zero Down Time Program Support in Semarang City Area 01006

Jaka Windarta, Nugroho Agus Darmanto, Mohamad Dwi K, Arya Java Y and Muhammad Refanza D K

Published online: 31 October 2022

DOI: <https://doi.org/10.1051/e3sconf/202235901006>

[PDF \(1.909 MB\)](#) | [References](#) | [NASA ADS Abstract Service](#)

[Open Access](#)

Inspecting Power Network Analysis on Eddy Current Test of SMAW Joints 01007

J.P. Rubijanto, Rusnaldy and D.H Gunawan

Published online: 31 October 2022

DOI: <https://doi.org/10.1051/e3sconf/202235901007>

[PDF \(2.133 MB\)](#) | [References](#) | [NASA ADS Abstract Service](#)

[Open Access](#)

Biomass Value Improvement and Techno-Economic Analytics in Power Plant 01008

Rahardi Santoso, Danianto Hendragiri and Iwa Garniwa

Published online: 31 October 2022

DOI: <https://doi.org/10.1051/e3sconf/202235901008>

[PDF \(1.923 MB\)](#) | [References](#) | [NASA ADS Abstract Service](#)

- Culture and Environmental Management

[Open Access](#)

The Effect of Perceived Green Human Resources Management on Perceived Environmental Performance with Employer Environmental Commitment and Green Lifestyle As an Intervening Variable 02001

Khairunnisak Khairunnisak and Suharnomo Suharnomo

Published online: 31 October 2022

DOI: <https://doi.org/10.1051/e3sconf/202235902001>

[PDF \(1.821 MB\)](#) | [References](#) | [NASA ADS Abstract Service](#)

[Open Access](#)

The Railway Children and Their Acts of Heroism 02002

Anastasia Intan Wardyani and Mytha Candria

Published online: 31 October 2022

DOI: <https://doi.org/10.1051/e3sconf/202235902002>PDF (1.867 MB) | [References](#) | [NASA ADS Abstract Service](#) [Open Access](#)

Ideological Criticism of the Realization of the Heritage City Structuring and Preservation Program (P3KP) in Indonesia: Rethinking the Importance of Preserving Ancient Manuscripts 02003

Ilham Ibnul Hakim and Nur Fauzan Ahmad

Published online: 31 October 2022

DOI: <https://doi.org/10.1051/e3sconf/202235902003>PDF (1.957 MB) | [References](#) | [NASA ADS Abstract Service](#) [Open Access](#)

Sunan Kudus Construction as Religious Icon for the People of Kudus Regency 02004

Sukarjo Waluyo, Redyanto Noor and Ratna Asmarani

Published online: 31 October 2022

DOI: <https://doi.org/10.1051/e3sconf/202235902004>PDF (1.706 MB) | [References](#) | [NASA ADS Abstract Service](#) [Open Access](#)

Construction of Ratu Kalinyamat as an Icon of Jepara Regency 02005

Nunung Kusumawati, Sukarja Waluyo and Ken Widyatwati

Published online: 31 October 2022

DOI: <https://doi.org/10.1051/e3sconf/202235902005>PDF (1.850 MB) | [References](#) | [NASA ADS Abstract Service](#) [Open Access](#)

Lurik as Javanese Low Class Society Local Wisdom of Utilizing Natural Resource for Clothing 02006

Fajar Safitri and Wiwiek Sundari

Published online: 31 October 2022

DOI: <https://doi.org/10.1051/e3sconf/202235902006>PDF (1.949 MB) | [References](#) | [NASA ADS Abstract Service](#) [Open Access](#)

Differences in Environmental Education at the Elementary School Level in Japan and Indonesia 02007

Lestari Errica and Budi Mulyadi

Published online: 31 October 2022

DOI: <https://doi.org/10.1051/e3sconf/202235902007>

PDF (1.846 MB) | [References](#) | [NASA ADS Abstract Service](#)

[Open Access](#)

Utilizing Lurik Waste for Handicraft Home Industry to Improve Low Class Family Income 02008

Wiwiek Sundari

Published online: 31 October 2022

DOI: <https://doi.org/10.1051/e3sconf/202235902008>

PDF (1.859 MB) | [References](#) | [NASA ADS Abstract Service](#)

[Open Access](#)

The Influence of *Unggah – Ungguh* as Javanese Culture in *Gereja Injili di Tanah Jawa (GITJ) Kudus*' Communication Processes for Sustaining Local Social-Environment 02009

Hanna Levina Goei and Nurhayati Nurhayati

Published online: 31 October 2022

DOI: <https://doi.org/10.1051/e3sconf/202235902009>

PDF (1.787 MB) | [References](#) | [NASA ADS Abstract Service](#)

[Open Access](#)

From Shallow to Deep Ecology in Hayao Miyazaki's *Ponyo on the Cliff by the Sea* 02010

Fatchu Dhofarudin and Fajria Noviana

Published online: 31 October 2022

DOI: <https://doi.org/10.1051/e3sconf/202235902010>

PDF (1.904 MB) | [References](#) | [NASA ADS Abstract Service](#)

[Open Access](#)

Japanese Daily Vlogger Content as A Cultural Learning Medium for College Students: Study Case of Diponegoro University's Student 02011

Yolanda Prayudanti and Dewi Saraswati Sakariah

Published online: 31 October 2022

DOI: <https://doi.org/10.1051/e3sconf/202235902011>

PDF (2.523 MB) | [References](#) | [NASA ADS Abstract Service](#)

[Open Access](#)

Metaphors and Cultural Values Part of Plants in Japanese Proverbs 02012

Aulia Nur Fitri and Elizabeth Ihan Rini

Published online: 31 October 2022

DOI: <https://doi.org/10.1051/e3sconf/202235902012>

PDF (1.885 MB) | [References](#) | [NASA ADS Abstract Service](#)

[Open Access](#)

Revealing the Elements of Popular Culture in the Coffee Shop Industries in Tembalang Sub-District, Semarang 02013

Rizky Farhan Anugrah and Rifka Pratama

Published online: 31 October 2022

DOI: <https://doi.org/10.1051/e3sconf/202235902013>

PDF (1.702 MB) | [References](#) | [NASA ADS Abstract Service](#)

[Open Access](#)

Analysis of Water Environment Support for Marine Ecotourism Suitability Category Diving in Ataúro Island 02014

Delio Da Costa, Fuad Muhammad and Budi Warsito

Published online: 31 October 2022

DOI: <https://doi.org/10.1051/e3sconf/202235902014>

PDF (1.975 MB) | [References](#) | [NASA ADS Abstract Service](#)

[Open Access](#)

Development Variety Decorate Industry Creative Craft Carving in Jepara and its Influence on Environment Culture Public Craftsman 02015

Sri Indrahti and Yuta Tri Waskita

Published online: 31 October 2022

DOI: <https://doi.org/10.1051/e3sconf/202235902015>

PDF (1.730 MB) | [References](#) | [NASA ADS Abstract Service](#)

[Open Access](#)

Students' Evaluation on Online Learning System at IUP Program, Faculty of Humanities Universitas Diponegoro 02016

Mualimin Mualimin

Published online: 31 October 2022

DOI: <https://doi.org/10.1051/e3sconf/202235902016>

PDF (1.817 MB) | [References](#) | [NASA ADS Abstract Service](#)

[Open Access](#)

Reissuing Indonesian Independent Music: Technology-Mediated Nostalgia, Hauntology and Future Projection 02017

Gregorius Tri Hendrawan Manurung and Khothibul Umam

Published online: 31 October 2022

DOI: <https://doi.org/10.1051/e3sconf/202235902017>

PDF (1.722 MB) | [References](#) | [NASA ADS Abstract Service](#)

[Open Access](#)

Values in The development of Science and Technology Contribution to Strengthening the national Cultural Character 02018

Sri Sudarsih

Published online: 31 October 2022

DOI: <https://doi.org/10.1051/e3sconf/202235902018>

PDF (1.668 MB) | [References](#) | [NASA ADS Abstract Service](#)

[Open Access](#)

Merchandise and Memorabilia: Between Art Products, Self-Image, and Musicians Existence 02019

Khothibul Umam and Gregorius Tri Hendrawan Manurung

Published online: 31 October 2022

DOI: <https://doi.org/10.1051/e3sconf/202235902019>

PDF (1.700 MB) | [References](#) | [NASA ADS Abstract Service](#)

[Open Access](#)

Family and Organizational Environment: Character Shaping of Maskani Azizah, Visionary Woman in Tegal City 02020

Siti Maziyah

Published online: 31 October 2022

DOI: <https://doi.org/10.1051/e3sconf/202235902020>

PDF (1.747 MB) | [References](#) | [NASA ADS Abstract Service](#)

[Open Access](#)

Symbolic Meaning Behind Traditional Rite "Sedekah Sampar Banyu" Wonolopo, Mijen Semarang 02021

Teshalonika Putri Eklesia Thenu and Laura Andri Retno Martini

Published online: 31 October 2022

DOI: <https://doi.org/10.1051/e3sconf/202235902021>

PDF (1.696 MB) | [References](#) | [NASA ADS Abstract Service](#)

[Open Access](#)

The Effect of Semester Level on Information Literacy Self-Efficacy by Vocational School Students of Diponegoro University During the Online Learning Period 02022

Ika Krismayani, Jumino, Yanuar Yoga Prasetyawan and Mecca Arfa

Published online: 31 October 2022

DOI: <https://doi.org/10.1051/e3sconf/202235902022>

PDF (1.709 MB) | [References](#) | [NASA ADS Abstract Service](#)

-
- [Open Access](#)
- The Society's Use of Digital Literary Reading Applications 02023
Ika Krismayani and Mecca Arfa
Published online: 31 October 2022
DOI: <https://doi.org/10.1051/e3sconf/202235902023>
PDF (1.757 MB) | [References](#) | [NASA ADS Abstract Service](#)
-
- [Open Access](#)
- Smoke-haze and Forest Fire in Kalimantan: How is the Reform regime responses?
02024
Yety Rochwulaningsih, Noor Naelil Masruroh, Fanada Sholihah, Rafngi Mufidah and Susilo Budiyanto
Published online: 31 October 2022
DOI: <https://doi.org/10.1051/e3sconf/202235902024>
PDF (1.762 MB) | [References](#) | [NASA ADS Abstract Service](#)
-
- [Open Access](#)
- The Existence of Paid Photocopy Services at the Gadjah Mada University (UGM)
Library in Era 4.0 02025
Mecca Arfa, Ika Krismayani and dan Rizal Gani Kaharudin
Published online: 31 October 2022
DOI: <https://doi.org/10.1051/e3sconf/202235902025>
PDF (1.593 MB) | [References](#) | [NASA ADS Abstract Service](#)
-
- [Open Access](#)
- "Tri hita karana"* Life ideology as a cultural identity of balinese society reflected in
elizabeth gilbert's eat pray love (Anthropological Approach In Literature) 02026
Hadiyanto Hadiyanto
Published online: 31 October 2022
DOI: <https://doi.org/10.1051/e3sconf/202235902026>
PDF (1.766 MB) | [References](#) | [NASA ADS Abstract Service](#)
-
- [Open Access](#)
- Halal Tourism: Capturing the Development and Potential of Halal Tourism in Japan
02027
Mellania Yustica and Arsi Widiandari
Published online: 31 October 2022
DOI: <https://doi.org/10.1051/e3sconf/202235902027>
PDF (1.847 MB) | [References](#) | [NASA ADS Abstract Service](#)
-
- [Open Access](#)

The cadets' understanding of the ballast water management convention 02028

Iksiroh El Husna, Nasri, Anissofiah Azise Wijinurhayati and Widya Putri

Published online: 31 October 2022

DOI: <https://doi.org/10.1051/e3sconf/202235902028>

PDF (1.714 MB) | [References](#) | [NASA ADS Abstract Service](#)

[Open Access](#)

Students' Perception toward Learning System at International Undergraduate Program (IUP), Faculty of Humanities, Diponegoro University 02029

Oktiva Herry Chandra

Published online: 31 October 2022

DOI: <https://doi.org/10.1051/e3sconf/202235902029>

PDF (1.720 MB) | [References](#) | [NASA ADS Abstract Service](#)

[Open Access](#)

Family Business Organizational Culture and Its Implications for Human Resources Success in the Legendary Milk Café Karangdoro Semarang 02030

Theresa Dinda Hermawan and Arido Laksono

Published online: 31 October 2022

DOI: <https://doi.org/10.1051/e3sconf/202235902030>

PDF (1.747 MB) | [References](#) | [NASA ADS Abstract Service](#)

[Open Access](#)

Developing the Motifs and The Strategies to Survive of Semarang Batik Creative Industries, in Semarang Central Java Province, Indonesia 02031

Dewi Yuliati and Endang Susilowati

Published online: 31 October 2022

DOI: <https://doi.org/10.1051/e3sconf/202235902031>

PDF (2.237 MB) | [References](#) | [NASA ADS Abstract Service](#)

[Open Access](#)

Why Must Journals at the University Level be Well Managed to Support the Era of University Independence? 02032

Evi Widowati, Atika Wijaya, Sri Kadarwati, Yoris Adi Maretta and Atno

Published online: 31 October 2022

DOI: <https://doi.org/10.1051/e3sconf/202235902032>

PDF (1.710 MB) | [References](#) | [NASA ADS Abstract Service](#)

[Open Access](#)

Risk Level Fire Emergency Handling among Semarang Heritage Area 02033

Ferry Hermawan, Nabil Amri Ghozali, Calysta Eka Suci, Frida Kistiani and Himawan Indarto

Published online: 31 October 2022

DOI: <https://doi.org/10.1051/e3sconf/202235902033>

PDF (3.263 MB) | [References](#) | [NASA ADS Abstract Service](#)

[Open Access](#)

Gold Green: A Survival Strategy of Farmers in Kayumas Village, Situbondo Regency 02034

Latifatul Izzah, Yety Rochwulaningsih, Yanuar Nurdiansyah, Suharto and IG. Krisnadi

Published online: 31 October 2022

DOI: <https://doi.org/10.1051/e3sconf/202235902034>

PDF (2.096 MB) | [References](#) | [NASA ADS Abstract Service](#)

[Open Access](#)

Laesan Traditional Arts: The Relationship of Natural Life with Human Behavior (Case Study in Lasem District, Rembang Regency) 02035

Siti Nur Hasisa and Muhammad Suryadi

Published online: 31 October 2022

DOI: <https://doi.org/10.1051/e3sconf/202235902035>

PDF (1.779 MB) | [References](#) | [NASA ADS Abstract Service](#)

[Open Access](#)

Tin Exploration and Protection of Local Varieties as Communal Intellectual Property in the Bangka Belitung Islands 02036

Darwance, Dwi Haryadi and Rafiqs Sari

Published online: 31 October 2022

DOI: <https://doi.org/10.1051/e3sconf/202235902036>

PDF (1.657 MB) | [References](#) | [NASA ADS Abstract Service](#)

[Open Access](#)

An Analysis of the post-COVID-19 Information Distribution on Social Media 02037

Athanasia Oktaviani Puspita Dewi, Aulia Isnaini and Mega Fitri Lestari

Published online: 31 October 2022

DOI: <https://doi.org/10.1051/e3sconf/202235902037>

PDF (1.735 MB) | [References](#) | [NASA ADS Abstract Service](#)

[Open Access](#)

Fee-Based Service as A Human Resource Development (Librarian) in Library of Gadjah Mada University 02038

Zumairotus Suaidah and Mecca Arfa

Published online: 31 October 2022

DOI: <https://doi.org/10.1051/e3sconf/202235902038>

PDF (1.699 MB) | References | NASA ADS Abstract Service

[Open Access](#)

Phytoremediation of Lead Contaminated Land Using Vetiver zizanooides and Citric Acid as Chelating Agent 02039

Yesi Clara Shinta, Sri Sumiyati and Badrus Zaman

Published online: 31 October 2022

DOI: <https://doi.org/10.1051/e3sconf/202235902039>

PDF (1.957 MB) | References | NASA ADS Abstract Service

- *Language and Environment*

[Open Access](#)

A Contrastive Analysis of Halliday's Theme System in Indonesian and English-Native Abstracts 03001

Agung Ginanjar Anjaniputra, Christianti Tri Hapsari and Zuhurul Anam

Published online: 31 October 2022

DOI: <https://doi.org/10.1051/e3sconf/202235903001>

PDF (2.048 MB) | References | NASA ADS Abstract Service

[Open Access](#)

"Dirty Energy" and Ecological Performativity in Contemporary English Poems: Critiquing Petro Culture of the Anthropocene 03002

Henrikus Joko Yulianto and Zuhurul Anam

Published online: 31 October 2022

DOI: <https://doi.org/10.1051/e3sconf/202235903002>

PDF (1.953 MB) | References | NASA ADS Abstract Service

[Open Access](#)

Natural Resources for The Nation's Prosperity (A Semiotic Study of the Song "Indonesia" by Rhoma Irama) 03003

Moh. Muzakka and Dewi Prihatini Maghfiroh

Published online: 31 October 2022

DOI: <https://doi.org/10.1051/e3sconf/202235903003>

PDF (1.765 MB) | References | NASA ADS Abstract Service

[Open Access](#)

Nature's Exploitation as A Cause of Natural Disaster (Riffatere Semiotic Studies Towards Rhoma Irama Song "Malapetaka") 03004

Dewi Prihatini Maghfiroh and Moh Muzakka

Published online: 31 October 2022

DOI: <https://doi.org/10.1051/e3sconf/202235903004>

PDF (1.826 MB) | [References](#) | [NASA ADS Abstract Service](#)

[Open Access](#)

The Meaning of Connotations with Natural Symbols in Song Lyrics of “Api dan Lautan”, “Bahtera Cinta”, and “Senandung Rindu” by Rhoma Irama 03005

Sri Puji Astuti and Risma Herninda

Published online: 31 October 2022

DOI: <https://doi.org/10.1051/e3sconf/202235903005>

PDF (1.727 MB) | [References](#) | [NASA ADS Abstract Service](#)

[Open Access](#)

Lexical Cohesion in Song Lyrics of “Malapetaka”, “Bencana”, and “Kemarau” by Rhoma Irama 03006

Hassya Ancelia Sapna and Sri Puji Astuti

Published online: 31 October 2022

DOI: <https://doi.org/10.1051/e3sconf/202235903006>

PDF (1.681 MB) | [References](#) | [NASA ADS Abstract Service](#)

[Open Access](#)

Functional Characteristics of “Language Game” in Tourism Promotion Text 03007

Ary Setyadi

Published online: 31 October 2022

DOI: <https://doi.org/10.1051/e3sconf/202235903007>

PDF (1.803 MB) | [References](#) | [NASA ADS Abstract Service](#)

[Open Access](#)

The Philosophy of Human Life in the Lexicon of the Laesan Traditional Art song in Lasem Rembang 03008

Muhammad Suryadi and Siti Nur Hasisah

Published online: 31 October 2022

DOI: <https://doi.org/10.1051/e3sconf/202235903008>

PDF (1.692 MB) | [References](#) | [NASA ADS Abstract Service](#)

[Open Access](#)

Nature vs. Culture in Hayao Miyazaki’s *Ponyo on the Cliff by the Sea* 03009

Fajria Noviana

Published online: 31 October 2022

DOI: <https://doi.org/10.1051/e3sconf/202235903009>

PDF (1.899 MB) | [References](#) | [NASA ADS Abstract Service](#)

-
- [Open Access](#)
- Anthropocentrism Ethics in Mari Okada's *Sayonara no Asa ni Yakusoku No Hana Wo Kazarou* 03010
- Muhammad Alif Nur Ramadhan and Zaki Ainul Fadli
- Published online: 31 October 2022
- DOI: <https://doi.org/10.1051/e3sconf/202235903010>
- [PDF \(1.820 MB\)](#) | [References](#) | [NASA ADS Abstract Service](#)
-
- [Open Access](#)
- Communication Patterns in the *Ageman Keris* Making Process in *Besalen Buwana Aji Kalingga*: an Ethnography of Communication Study 03011
- Suwarno Peter, Kurniawan Julius Novan Deni and Nurhayati Nurhayati
- Published online: 31 October 2022
- DOI: <https://doi.org/10.1051/e3sconf/202235903011>
- [PDF \(1.810 MB\)](#) | [References](#) | [NASA ADS Abstract Service](#)
-
- [Open Access](#)
- A Collocation Analysis of 'energy' in Brown Family Corpus 03012
- Prihantoro
- Published online: 31 October 2022
- DOI: <https://doi.org/10.1051/e3sconf/202235903012>
- [PDF \(2.023 MB\)](#) | [References](#) | [NASA ADS Abstract Service](#)
-
- [Open Access](#)
- Language-skill Learning Achievement as an Information System at IUP Program, Faculty of Humanities, Universitas Diponegoro 03013
- Catur Kepirianto
- Published online: 31 October 2022
- DOI: <https://doi.org/10.1051/e3sconf/202235903013>
- [PDF \(1.671 MB\)](#) | [References](#) | [NASA ADS Abstract Service](#)
-
- [Open Access](#)
- Contrastive Analysis of Onomatopoeic Use in Nursery Rhymes as Children's Environmental Sounds Recognition in Japanese and Indonesian 03014
- Naila Nabila Rosyadi and Nur Hastuti
- Published online: 31 October 2022
- DOI: <https://doi.org/10.1051/e3sconf/202235903014>
- [PDF \(2.139 MB\)](#) | [References](#) | [NASA ADS Abstract Service](#)
-
- [Open Access](#)

The Role of the Environment in Shaping the Characters in the Novel *Merindu Baginda Nabi* by Habiburrahman El Shirazy 03015

Fajrul Falah and Iva Yuliana

Published online: 31 October 2022

DOI: <https://doi.org/10.1051/e3sconf/202235903015>

PDF (1.648 MB) | [References](#) | [NASA ADS Abstract Service](#)

[Open Access](#)

Culture in the Pesantren Environment in shaping Figures' Character in Novel *Merindu Baginda Nabi* by Habiburrahman el-Shirazy 03016

Fajrul Falah

Published online: 31 October 2022

DOI: <https://doi.org/10.1051/e3sconf/202235903016>

PDF (1.721 MB) | [References](#) | [NASA ADS Abstract Service](#)

[Open Access](#)

Digital Literacy Assessment Model in Learning Management System: A Self-Directed Learning Perspective 03017

Ana Irhandayaningsih

Published online: 31 October 2022

DOI: <https://doi.org/10.1051/e3sconf/202235903017>

PDF (1.735 MB) | [References](#) | [NASA ADS Abstract Service](#)

[Open Access](#)

The Relationship Between Metacognitive Experiences and Digital Literacy in a Self-Directed Learning Environment 03018

Ana Irhandayaningsih and Sufyan Mulana Hastoto

Published online: 31 October 2022

DOI: <https://doi.org/10.1051/e3sconf/202235903018>

PDF (1.680 MB) | [References](#) | [NASA ADS Abstract Service](#)

[Open Access](#)

The Diffusion of Innovations Elements in Library Science Journals 03019

Siti Mas Fuah and Roro Isyawati Permata Ganggi

Published online: 31 October 2022

DOI: <https://doi.org/10.1051/e3sconf/202235903019>

PDF (1.691 MB) | [References](#) | [NASA ADS Abstract Service](#)

[Open Access](#)

Natural Methapors of Symbols and Social Impact in Sakura Song Lyrics By Ikimono Gakari 03020

Nur Hastuti

Published online: 31 October 2022

DOI: <https://doi.org/10.1051/e3sconf/202235903020>

PDF (1.814 MB) | [References](#) | [NASA ADS Abstract Service](#)

[Open Access](#)

Choice of Words Based on Meaning in Rhoma Irama Songs with Environmental Themes 03021

Eka Sifa Ariyanti, Merry Ivana Febriyanti and Mujid Farihul Amin

Published online: 31 October 2022

DOI: <https://doi.org/10.1051/e3sconf/202235903021>

PDF (1.664 MB) | [References](#) | [NASA ADS Abstract Service](#)

[Open Access](#)

Morphosyntec in Verbal Messages Angry Expressions in The Film *Dua Garis Biru* 03022

Meinar Trifidya and Riris Tiani

Published online: 31 October 2022

DOI: <https://doi.org/10.1051/e3sconf/202235903022>

PDF (1.768 MB) | [References](#) | [NASA ADS Abstract Service](#)

[Open Access](#)

Ecocriticism of Poaching in Doraemon: Nobita no Kyouryuu Anime Movie 03023

Anggita Prameswari and Yuliani Rahmah

Published online: 31 October 2022

DOI: <https://doi.org/10.1051/e3sconf/202235903023>

PDF (1.800 MB) | [References](#) | [NASA ADS Abstract Service](#)

[Open Access](#)

Social Media Naming as Part of Teenager Constructed Identity 03024

Dwi Wulandari

Published online: 31 October 2022

DOI: <https://doi.org/10.1051/e3sconf/202235903024>

PDF (1.745 MB) | [References](#) | [NASA ADS Abstract Service](#)

[Open Access](#)

"Language Game": Elements of Word Sound in Tourism Promotion Texts 03025

Rizki Dwi Nuradita

Published online: 31 October 2022

DOI: <https://doi.org/10.1051/e3sconf/202235903025>

PDF (1.771 MB) | References | NASA ADS Abstract Service



Lexical Diction in The Lyrics of Songs Rhoma Irama with The Theme of The Environment 03026

Mujid Farihul Amin, Eka Sifa Ariyanti and Merry Ivana Febriyanti

Published online: 31 October 2022

DOI: <https://doi.org/10.1051/e3sconf/202235903026>

PDF (1.613 MB) | References | NASA ADS Abstract Service



Representation of Anthropocentric and Ecocentric Figures in Hayao Miyazaki's Princess Mononoke 03027

Zaki Ainul Fadli

Published online: 31 October 2022

DOI: <https://doi.org/10.1051/e3sconf/202235903027>

PDF (1.805 MB) | References | NASA ADS Abstract Service



The Environmental Problem in Anime *Weathering With You* Directed By Makoto Shinkai 03028

Budi Mulyadi

Published online: 31 October 2022

DOI: <https://doi.org/10.1051/e3sconf/202235903028>

PDF (1.882 MB) | References | NASA ADS Abstract Service



The Communication Pattern of Wahyu Turonggo Aji Reog Dance in Merti Dusun Kemawi Sumowono as a means of Preserving Environment 03029

Ninik Elika and Nurhayati Nurhayati

Published online: 31 October 2022

DOI: <https://doi.org/10.1051/e3sconf/202235903029>

PDF (1.842 MB) | References | NASA ADS Abstract Service

- *History and Environment*



Jlamprang Batik: Pekalongan Cultural Identity from Natural Resources in the Environment 04001

Alvatica Devina and Atrinawati Atrinawati

Published online: 31 October 2022

DOI: <https://doi.org/10.1051/e3sconf/202235904001>

PDF (1.904 MB) | [References](#) | [NASA ADS Abstract Service](#)

[Open Access](#)

Capitalism, Plantation Industry, and Environmental Change: East Sumatra During the Late Dutch Colonial State in Indonesia 04002

Singgih Tri Sulistiyono, Yety Rochwulaningsih, Noor Naelil Masruroh, Salina Zainol and Saparudin Baru

Published online: 31 October 2022

DOI: <https://doi.org/10.1051/e3sconf/202235904002>

PDF (1.750 MB) | [References](#) | [NASA ADS Abstract Service](#)

[Open Access](#)

Jlamprang Batik Patterns as Pekalongan Local Wisdom of Using Batik Technique 04003

Atrinawati Atrinawati

Published online: 31 October 2022

DOI: <https://doi.org/10.1051/e3sconf/202235904003>

PDF (1.876 MB) | [References](#) | [NASA ADS Abstract Service](#)

[Open Access](#)

Islam and Local Wisdom: The Study of "*Islam Nusantara*" in the Cultural Perspective 04004

Mudjahirin Thohir

Published online: 31 October 2022

DOI: <https://doi.org/10.1051/e3sconf/202235904004>

PDF (1.792 MB) | [References](#) | [NASA ADS Abstract Service](#)

[Open Access](#)

Moderation of Religiosity in The View of Islam Nusantara 04005

Mudjahirin Thohir and M. Lukluk Atsmara Anjaina

Published online: 31 October 2022

DOI: <https://doi.org/10.1051/e3sconf/202235904005>

PDF (1.733 MB) | [References](#) | [NASA ADS Abstract Service](#)

[Open Access](#)

Parties and Environmental Issues: PDIP Action Programs in the Reformation Era, 2002-2014 04006

Agustina Wilujeng Pramestusi, Yety Rochwulaningsih and Singgih Tri Sulistiyono

Published online: 31 October 2022

DOI: <https://doi.org/10.1051/e3sconf/202235904006>

PDF (1.767 MB) | References | NASA ADS Abstract Service

[Open Access](#)

Transfer Ride of The Legend of Rawa Pening: Its Potential to be Literary Tourism
04007

Azzahra Shahnaz and Hermintoyo Muhamad

Published online: 31 October 2022

DOI: <https://doi.org/10.1051/e3sconf/202235904007>

PDF (1.649 MB) | References | NASA ADS Abstract Service

[Open Access](#)

Sandstone Provenance Study in Wonosegoro, Boyolali Regency, Central Java 04008

Mohammad Bimo Prabowo, Nurakhmi Qadaryati and Dian Agus Widiarso

Published online: 31 October 2022

DOI: <https://doi.org/10.1051/e3sconf/202235904008>

PDF (2.021 MB) | References | NASA ADS Abstract Service

[Open Access](#)

The Legend of Rawa Pening as a Potential Literary Tourism Destination 04009

Hermintoyo Muhamad and Nugroho Rian Destianto

Published online: 31 October 2022

DOI: <https://doi.org/10.1051/e3sconf/202235904009>

PDF (1.650 MB) | References | NASA ADS Abstract Service

- Information System Management and Environment

[Open Access](#)

Auto Labeling to Increase Aspect-Based Sentiment Analysis Using K-Nearest
Neighbors Method 05001

Ahmad Jazuli, Widowati and Retno Kusumaningrum

Published online: 31 October 2022

DOI: <https://doi.org/10.1051/e3sconf/202235905001>

PDF (1.984 MB) | References | NASA ADS Abstract Service

[Open Access](#)

Key Performance Indicator for Multi Branch Employee Performance Assessment
Based on Simple Additive Weighting 05002

Daniel Yeri Kristiyanto, Didi Supriyadi and Fivy Nur Safitri

Published online: 31 October 2022

DOI: <https://doi.org/10.1051/e3sconf/202235905002>

PDF (2.085 MB) | References | NASA ADS Abstract Service

-
- [Open Access](#)
- Hybrid Model Based on Technology Acceptance Model (TAM) & Information System Success Model (ISSM) in Analyzing the Use of E-Health 05003
Shinta Krisdina, Oky Dwi Nurhayati and Dinar Mutiara Kusumo Nugraheni
Published online: 31 October 2022
DOI: <https://doi.org/10.1051/e3sconf/202235905003>
PDF (1.962 MB) | [References](#) | [NASA ADS Abstract Service](#)
-
- [Open Access](#)
- Supply Chain Mapping to Prepare Golden Generation 2045 for Future Technology Infrastructure 05004
Johanes Fernandes Andry, Filscha Nurprihatin and Lydia Liliana
Published online: 31 October 2022
DOI: <https://doi.org/10.1051/e3sconf/202235905004>
PDF (1.900 MB) | [References](#) | [NASA ADS Abstract Service](#)
-
- [Open Access](#)
- The Future of Mobile Commerce Application in a Post Pandemic Period; An Integrative Model of UTAUT2 05005
Muhammad Ashoer, Muhammad Haerdiansyah Syahnur, Juliyanti Sidik Tjan, Asriani Junaid, Andika Pramukti and Abdul Halim
Published online: 31 October 2022
DOI: <https://doi.org/10.1051/e3sconf/202235905005>
PDF (1.810 MB) | [References](#) | [NASA ADS Abstract Service](#)
-
- [Open Access](#)
- An Overview of EV Roaming Protocols 05006
Dwidharma Priyasta, Hadiyanto and Reza Septiawan
Published online: 31 October 2022
DOI: <https://doi.org/10.1051/e3sconf/202235905006>
PDF (2.178 MB) | [References](#) | [NASA ADS Abstract Service](#)
-
- [Open Access](#)
- Interpreting Communication and Information Technology as an Effort to Grow a Nationalist Attitude towards Society 5.0 05007
Fidel Satrio Hadiyanto and Sri Sudarsih
Published online: 31 October 2022
DOI: <https://doi.org/10.1051/e3sconf/202235905007>
PDF (1.672 MB) | [References](#) | [NASA ADS Abstract Service](#)

-
- [Open Access](#)
Information Literacy by Diponegoro University Library Science S1 Students of Batch 2020 in Fulfilling Their Information Needs 05008
Zahra Dzahabiyya Utama and Jumino Jumino
Published online: 31 October 2022
DOI: <https://doi.org/10.1051/e3sconf/202235905008>
[PDF \(1.635 MB\)](#) | [References](#) | [NASA ADS Abstract Service](#)
-
- [Open Access](#)
Saving the Nusantara's Ulama Scientific Treasures with Digitization 05009
Nur Fauzan Ahmad and Ilham Ibnul Hakim
Published online: 31 October 2022
DOI: <https://doi.org/10.1051/e3sconf/202235905009>
[PDF \(1.910 MB\)](#) | [References](#) | [NASA ADS Abstract Service](#)
-
- [Open Access](#)
Acceptance Analysis of Silacak Version 3.0 Based on The Technology Acceptance Model (TAM) in Surabaya City 05010
Putri Alifia Nikmaturochmah, Dwi Handayani, Mursyidul Ibad and Abdul Hakim Zakkiy Fasya
Published online: 31 October 2022
DOI: <https://doi.org/10.1051/e3sconf/202235905010>
[PDF \(1.851 MB\)](#) | [References](#) | [NASA ADS Abstract Service](#)

- *Social Environment*

- [Open Access](#)
Lomban Traditions and Preservation of the Marine Environment in Jepara 06001
Alamsyah, Vicky Verry Angga and Danik Fitriani
Published online: 07 December 2022
DOI: <https://doi.org/10.1051/e3sconf/202235906001>
[PDF \(1.778 MB\)](#) | [References](#) | [NASA ADS Abstract Service](#)
-
- [Open Access](#)
Communication Strategy in Cultural Evolution Through Verbal Expression on Film *Dua Garis Biru* 06002
Riris Tiani and Meinar Trifidya
Published online: 07 December 2022
DOI: <https://doi.org/10.1051/e3sconf/202235906002>
[PDF \(1.726 MB\)](#) | [References](#) | [NASA ADS Abstract Service](#)
-
- [Open Access](#)

Islam nusantara: tracing the traces of KH sholeh darat thought in *pesantren* literature 06003

Muhammad Abdullah

Published online: 07 December 2022

DOI: <https://doi.org/10.1051/e3sconf/202235906003>

[PDF \(1.807 MB\)](#) | [References](#) | [NASA ADS Abstract Service](#)

[Open Access](#)

Barriers and Opportunities for Breast Cancer Prevention Measures 06004

Lilis Novitarum, Muhammad F. G. Siregar, Fazidah A. Siregar and Namora L. Lubis

Published online: 07 December 2022

DOI: <https://doi.org/10.1051/e3sconf/202235906004>

[PDF \(1.759 MB\)](#) | [References](#) | [NASA ADS Abstract Service](#)

[Open Access](#)

Perception the Role of Dalihan Na Tolu Traditional in Prevention of Type 2 Diabetes Mellitus among High Risk Population 06005

Soep, Albiner Siagian, Fazidah A. Siregar and Erna Mutiara

Published online: 07 December 2022

DOI: <https://doi.org/10.1051/e3sconf/202235906005>

[PDF \(1.780 MB\)](#) | [References](#) | [NASA ADS Abstract Service](#)

E3S Web of Conferences

eISSN: 2267-1242



 edp sciences

[Mentions légales](#)

[Contacts](#)

[Privacy policy](#)

A Vision4Press website

Improvement the Capacity of Electrical Energy in Residential Using PV With On-Grid System

Adhi Kusmantoro^{1*}, and Irma Farikhah²

¹*Department of Electrical Engineering, University of PGRI Semarang, Semarang, Indonesia*

²*Department of Mechanical Engineering, University of PGRI Semarang, Semarang, Indonesia.*

Abstract. As one of the renewable energy sources, sunlight or solar energy is considered appropriate to be one of the alternative sources of electrical energy that can be used. In this study, an on-grid system simulation model was carried out using PV. The goal is to find out the characteristics of the energy obtained using the control logic algorithm. In this simulation model design, previously calculations were carried out to determine pv capacity, because it will be adjusted to the power capacity used in residential houses. In this discussion, it is in accordance with the electricity needs of residential houses of 1,500 Watts or hourly energy consumption of 1.5 KWh. This electrical load will be on at 07.00 to 17.00, meaning that this electric load will consume electric power for 10 hours. Then the total energy consumed per day is 1.5 KWh. In this simulation, 2 100 Wp (Watt peak) solar panels with an output voltage of 12 V DC are used. In a day, it can more or less produce electricity of 200 Wp x 10 hours of heating = 2,000 Wh.

1 Introduction

Electrical energy is a very important energy for human life, the current need for energy as a driver of life is increasing. This is driven by a surge in the number of human populations, especially in developing countries, while the availability of existing power supplies is also unable to meet these increasing needs, therefore a renewable energy source is needed [1]. Renewable energy in general can be defined as energy obtained from natural sources that exist around humans and we can obtain it for free. As one of the renewable energy sources, sunlight or solar energy is considered appropriate to be one of the alternative sources of electrical energy that can be used. Solar energy is a clean, renewable energy, and is available for a long time. This solar energy source is also the most commonly utilized renewable energy today and this solar energy can be converted into electrical energy [2]. The use of sunlight using solar panels as a power plant began to be developed to reduce the use of fossil fuels. Solar panels have advantages such as being environmentally friendly because they do not have waste that causes pollution, are cheap to maintain, and are easy to apply [3].

Solar panels are semiconductor components that can convert solar energy into electrical energy. However, because the different levels of solar energy irradiation on a daily basis cause the output power of the solar panels to vary and not be optimal, therefore a model that

* Corresponding author: adhikusmantoro@upgris.ac.id

resembles the characteristics of actual solar cells is needed, so we can conduct a simple experiment from some data to find out how to get the maximum possible performance and maintain it [4]. From the last decade there has been an increase in demand for electricity, this will lead to a depletion of fossil fuels resulting in an increase in costs. To solve this problem, micro-grids (MG) are introduced and supported by renewable distributed generating systems (DG), such as, micro turbines, fuel cells, solar photovoltaics (PV) and wind generation due to limited fossil fuels [5]. From the above sources, solar energy provides tremendous benefits including environmental friendliness, surplus availability and low installation costs due to advanced technology and mass production [6]. Distributed generating systems (DG) are increasingly recognized as an alternative source to conventional central power supplies. The main component of the on-grid PV system is the GTI which functions to regulate the voltage and current received from the solar panels and ensures that the power supply is in line with the grid power. On the AC side, the sinusoidal output is synchronized to the grid frequency (50Hz) [7]. A study conducting a cost analysis and the benefits of adopting solar energy technology showed that PV systems are more cost-effective in the long run compared to PLN's electricity supply. Although the initial investment is relatively high in the PV system, it is a reliable investment in the long term [8]. Renewable energy sources such as wind or PV cannot provide a sustainable energy supply for loads due to weather changes [9]. Electrical energy systems using photovoltaics have an increasing role in on-grid systems, this is due to the decline in the world's conventional energy sources. A stand-alone photovoltaic energy system is a complete set of interconnected components for converting direct solar radiation into electricity and generally consists of PV plants, batteries, DC converters, inverters, and system loads [10]. A photovoltaic system also called a solar power system or PV system, is a power system designed to supply solar power that can be used through photovoltaics [11]. Photovoltaic (PV) systems connected to the network operating in changing weather conditions have been modeled and this model has been developed mainly for residential use [12]. Photovoltaic power systems can be used to provide an alternative source of electric power to homes to meet their daily energy needs through the direct conversion of solar radiation into electricity [13]. For on-grid solar energy systems, homes use electricity from local grids and PV arrays to meet consumers' own power demands and reduce electricity bills. The PV panel is connected with inverters and networks that directly convert DC power into AC power (220 V, 50 Hz) [14]. In on-grid systems, available solar energy may exceed the demand during high sunlight intensity. This study was conducted to explore the possibility of using PV systems in housing [15]. On-grid systems without storage cannot supply power on nighttime or rainy days when there is insufficient sunlight. Again, power output from certain renewable energy sources, such as wind and solar, can be intermittent [16]. Solar energy will be converted into AC using an inverter and DC energy obtained from the sun will be stored in batteries to provide DC supply to DC equipment [17]. The electrical energy produced and stored completely in the battery is sufficient to meet the demand for total loads throughout the year, which means a suitable solution to solve the power grid outage [18].

In this study, an on-grid system using PV is proposed to supply electrical energy to residential areas. This system is used to help meet the electricity needs of the utility grid. With this system, excess electrical energy can be channeled to the utility grid. Inverter settings use logic control method.

2 PV Modeling

Solar cell simulation models have been formulated [19] to predict and calculate potential output of PV cells. The solar cell can be simulated with the circuit shown in Figure 1. The correlation between the cell current I and the cell voltage V is shown in equation as follows

$$I = I_{pv} - I_0 \left\{ e^{\left(\frac{V + R_s I}{n V_t} \right)} - 1 \right\} - I_{sh} \quad (1)$$

In ideal conditions R_{sh} has a very large value so that the current flowing in the resistance is small, while R_s has a very small value to avoid a drop in the output voltage. The current flowing in the resistance R_{sh} can be expressed mathematically by the following equation

$$I_{sh} = \frac{V + R_s I}{R_{sh}} \quad (2)$$

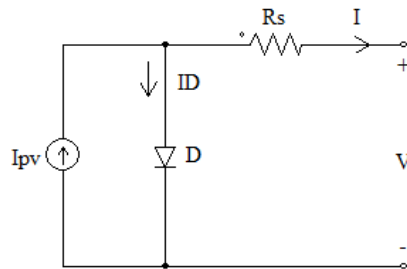

Fig. 1. PV equivalent circuit.

3 On-Grid System

A PV system connected to a grid that uses solar energy sources can generate electricity wherever it is connected to a utility grid. When sunlight hits the solar panel, the panel converts the energy of the sun into electricity that can power the load. Whether power is drawn from the PV system or whether the mains load power remains the same. The DC power of the PV system is reduced / boosted by the DC-DC boost / back converter respectively. The DC power generated by the DC-DC converter is converted to AC by the inverter. This AC current is the standard current used for most loads. Current flows from the inverter to the electrical control panel, which distributes the current to all loads. An optional tracking meter can track the total power consumption of all loads, the total performance of the solar system, and more. These tracking systems often include live display systems or online monitors that can track the amount of power the system is using and its performance at a particular point in time. If the output of the solar system exceeds the consumer during the day, the surplus power will be fed back to the grid. In this case, the electricity meter will rotate in the opposite direction. The fact that a solar array consumes more power than it produces overnight means that the extra energy needed to carry out the load is drawn from the grid as usual. Using batteries as energy storage in these grid-connected systems is not a fallback option as the grid provides the required load in the event of a PV power failure. A typical grid-tied PV system is shown in Figure 5 [20].

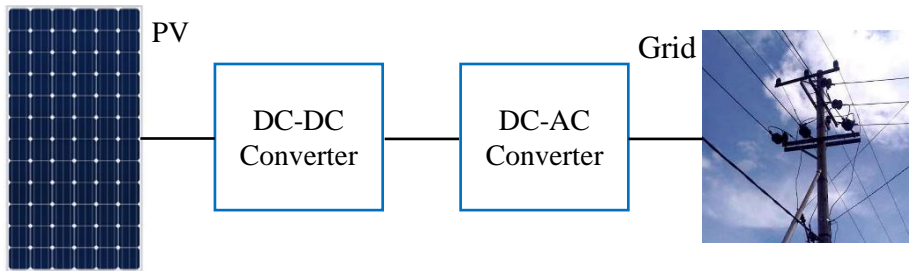

Fig. 2. On-grid system.

4 On-Grid System Design

This system does not require a battery storage system, the components used in the on-grid system are PV, DC-DC converters, and inverters. The inverter used is an inverter whose output voltage can be synchronized with the utility grid AC voltage. The on-grid system can work when there is a source from the utility grid, in this case the frequency and phase angle of the utility grid source become the reference.

4.1 Load Capacity Calculation

In the design of this model, previously calculations were carried out to determine the PV capacity, because it will be adjusted to the power capacity used in residential houses. In this discussion, it is in accordance with the electricity needs of residential houses of 1,500 Watts or hourly energy consumption of 1.5 KWh. This electrical load will be on at 07.00 to 17.00, meaning that this electric load will consume electric power for 10 hours. Then the total energy consumed per day is:

- ✓ Total energy = 1.5 KW x 10 = 1.5 KW/day.
- ✓ So the overall total energy required is 1.5 KWh.

For electrical energy storage systems used 12 Volt batteries with a capacity of 100 Ah each. For battery needs, the calculation is carried out as follows:

- ✓ The electric current per day is $1,500 / (12 \times 10) = 12.5$ Amperes
- ✓ Number of batteries = $1,500 \text{ Watts/day} : (12 \times 50 \text{ Ah}) = 3$ batteries
- ✓ Battery supplied power = 1800 watts

The need for batteries with consideration can serve the needs of every day without sunlight, then, if we use a battery that is 50 Ah 12 V, then we need 3 batteries ($50 \times 12 \times 3 = 1,800$ watts).

4.2 Capacity Calculation

From the calculation of energy consumption above of 1.5 Kwh or 1,500 Wh, then we can choose the size of the solar panel we need. In this design we use a 100 Wp (Watt peak) solar panel, that is, this panel will produce a maximum of 100 Watts at a voltage of 12 V DC per hour, so that if this solar panel is installed a day (07.00-17.00 = 10 hours) assuming it is not cloudy or the intensity of sunlight is constant then this solar panel can produce electricity $100 \text{ Wp} \times 10 \text{ hours} = 1000 \text{ Wh}$ or as much as 1 KWh. Power output of a 100 Wp solar panel is produced at a temperature condition of 25 °C, pressure 1.5 atm, with a light intensity of 1000 W/m². Actually the average 100 Wp solar panel will only produce an average electrical energy of about 300 Wh – 400 Wh in one day. This is due to the factor of unequal sunlight intensity throughout the day. In the design using 100 Wp solar panels, the following

calculations are used: $1,500 / 100 \times 10 = 2$ solar panels. So the electricity generated is 2 units $\times 100 \text{ Wp} = 200 \text{ Watts}$ per hour of heating at the peak of heating. In a day, it can more or less produce electricity of $200 \text{ Wp} \times 10 \text{ hours of heating} = 2,000 \text{ Wh}$.

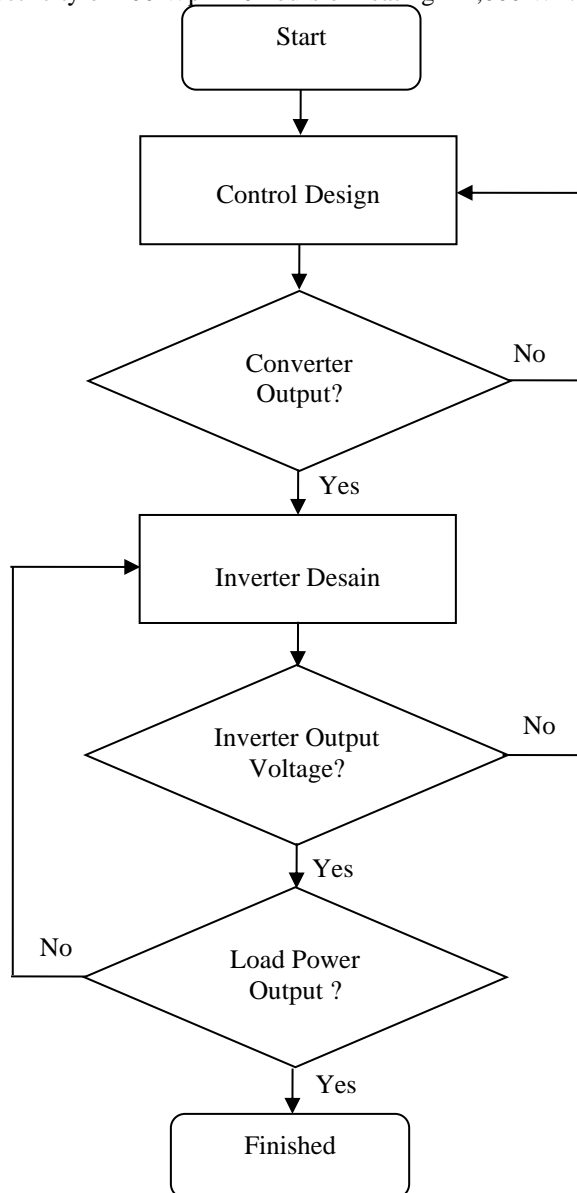

Fig. 3. Research algorithm.

4.3 Simulation Model Design

In making a simulation design using Matlab, the number and value of components are entered according to the results of manual calculations. For PV in this simulation using type TSM-230PD05.10. The amount of PV used two solar panels are connected in series. Meanwhile, in testing the intensity and temperature of the sun for PV, it is carried out with changes in the *irradiance* of solar energy and temperature as follows:

- ✓ Irradiance 1000 W/m², temperature 20 °C
- ✓ Irradiance 1000 W/m², temperature 35 °C
- ✓ Irradiance 500 W/m², temperature 20 °C
- ✓ Irradiance 500 W/m², temperature 35 °C

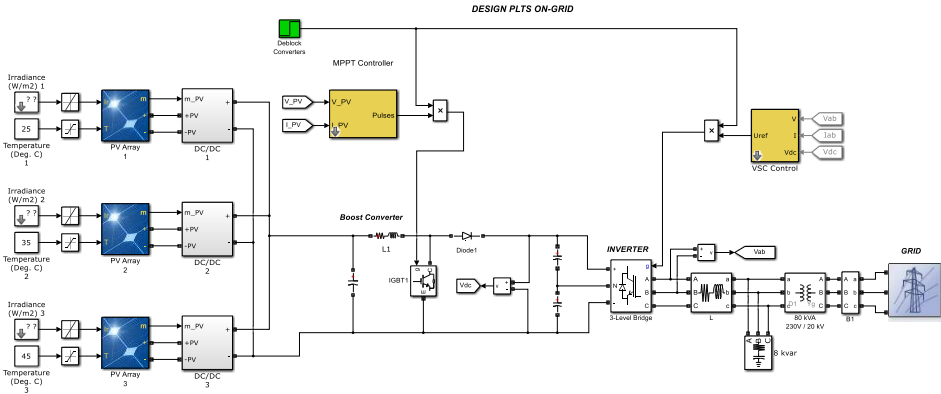

Fig. 4. On-Grid System Model.

5 Results and Discussion

The number of strings and the number of solar panels used in accordance with the planning, the intensity of solar radiation used is 1000 W /m² with different temperatures for each string. In the simulation model multiple DC converters are used.

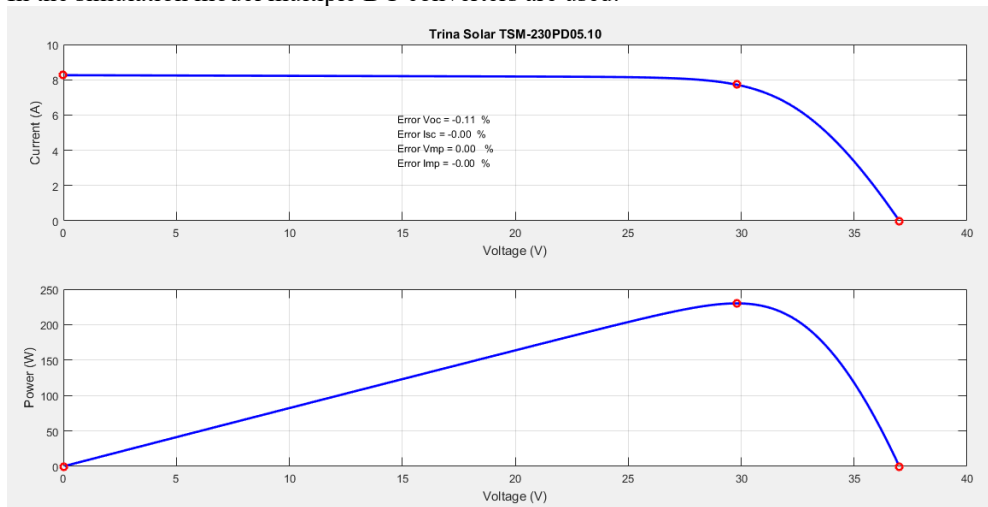

Fig. 5. PV characteristics.

Figure 5 shows the PV characteristics used in the on-grid system design. The measurement of the PV output power in the on-grid system was carried out at the same temperature and radiation intensity, namely at 1000 w/m² and 30 C. In addition, the results of the measurement of the PV output power were compared with the use of different controls on the DC-DC converter. Figure 6 shows the PV output power when the DC-DC converter uses the PI control. The resulting PV output power is 1250 Watt. The output power reaches the reference value in 0.17 seconds. Figure 7 shows the PV output power when using a

conventional control, which is 1100 watts. It takes 0.18 seconds to reach the reference value. The output power produced is lower when compared to using a PI control. In addition, the time required to reach the reference value is also 0.01 seconds longer.

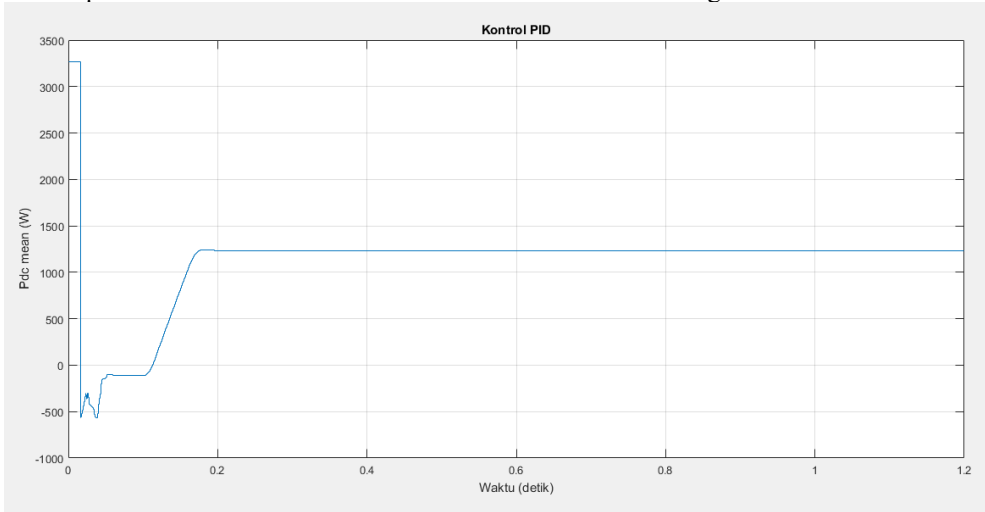

Fig. 6. PV output power with PI control.

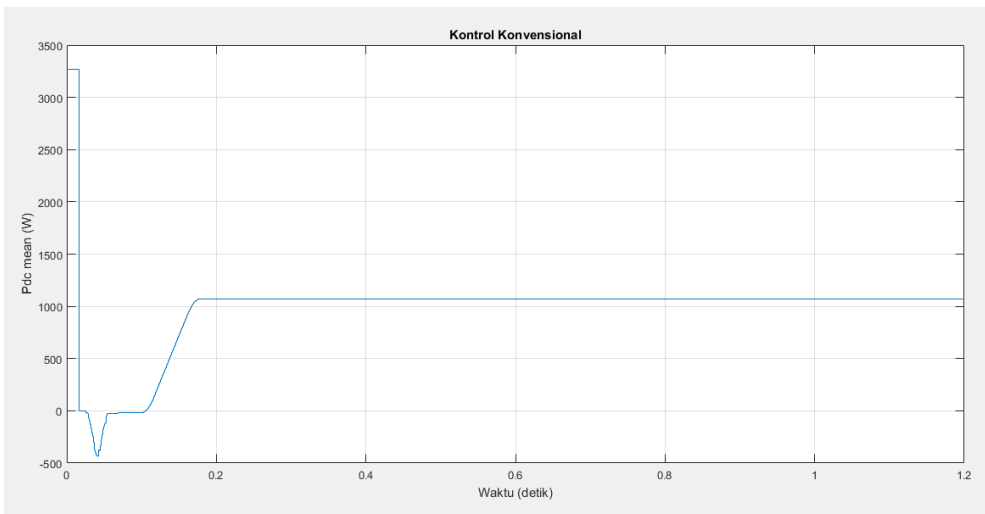

Fig. 7. PV output power with conventional control.

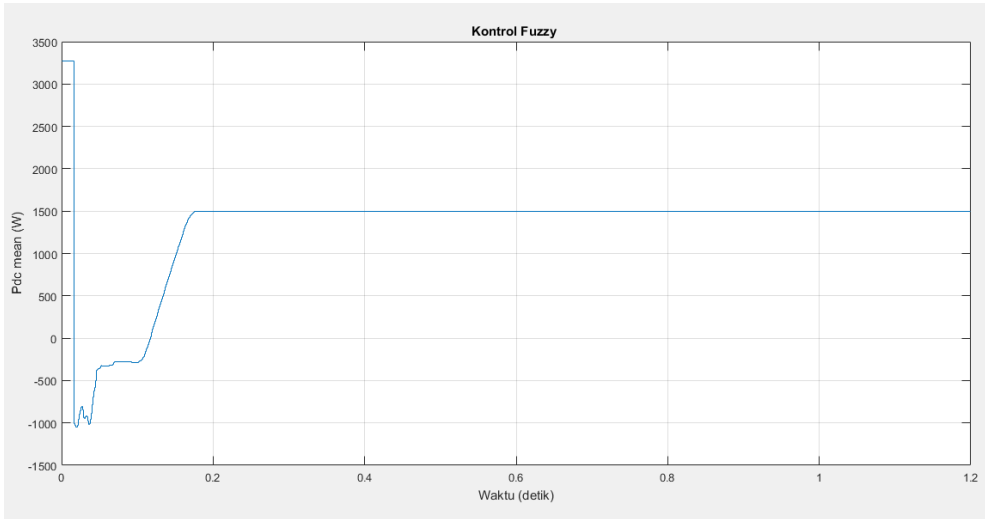

Fig. 8. PV output power with logic control.

Figure 8 shows the PV output power using control logic. The resulting output power is 1500 watts. The time required to reach the reference value is 0.165 seconds. Of the three control methods used in the DC-DC converter, control logic is able to adjust the DC-DC converter to produce maximum output power.

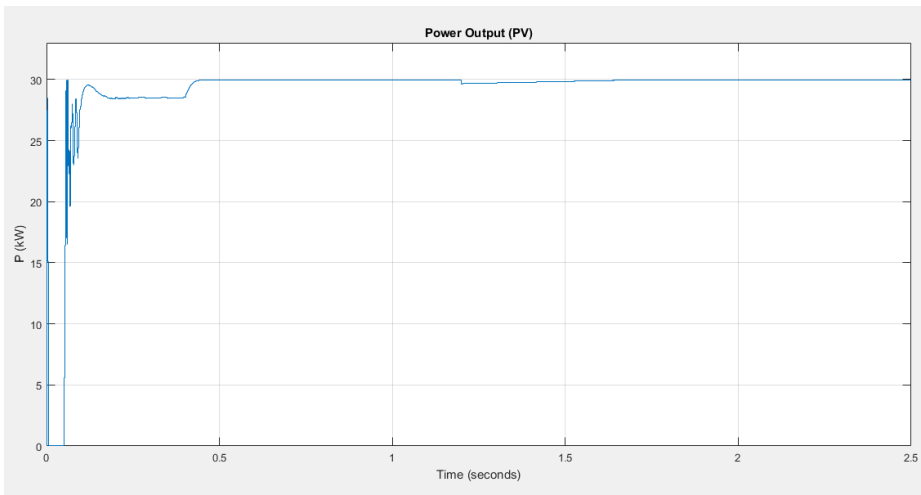

Fig. 9. PV output power (1000 W / m², 25 C).

Figure 9 – 11 shows the PV output power in several residential houses connected to the DC bus. Measurements are made by looking at changes in the intensity of solar radiation and ambient temperature. Figure 9 shows the results of the PV power output test with 1000 W/m² irradiation and a temperature of 25 C which produces a maximum power output of 30 KW. While Figure 10 shows if the irradiance is reduced by 700 W/m² it will affect the amount of PV output power, which is 27.5 Kw.

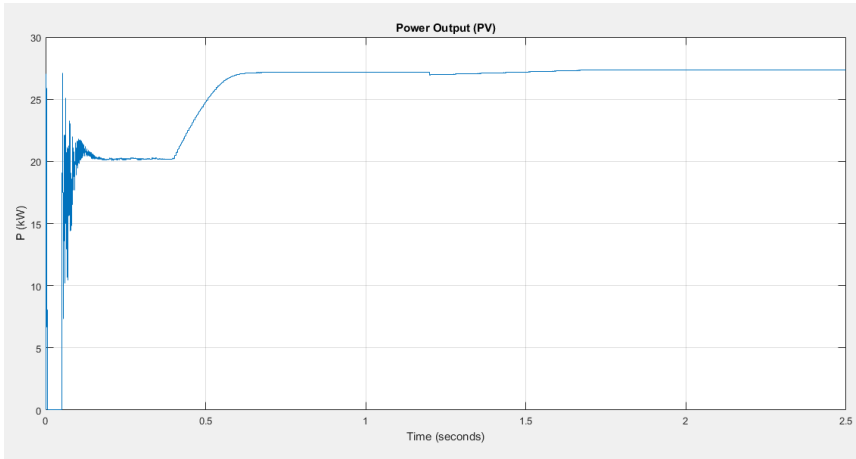

Fig. 10. PV output power (700 W / m², 25 C).

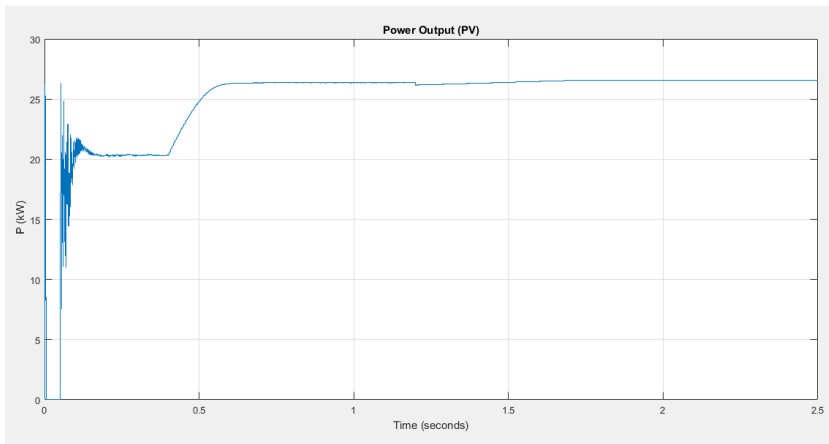

Fig. 11. PV output power (700 W / m², 35 C).

Figure 11 shows, if the temperature rises to 35°C it does not cause too much change in the PV output power, which is 27.6 Kw. The DC voltage generated by the DC-DC converter is the input voltage of the inverter

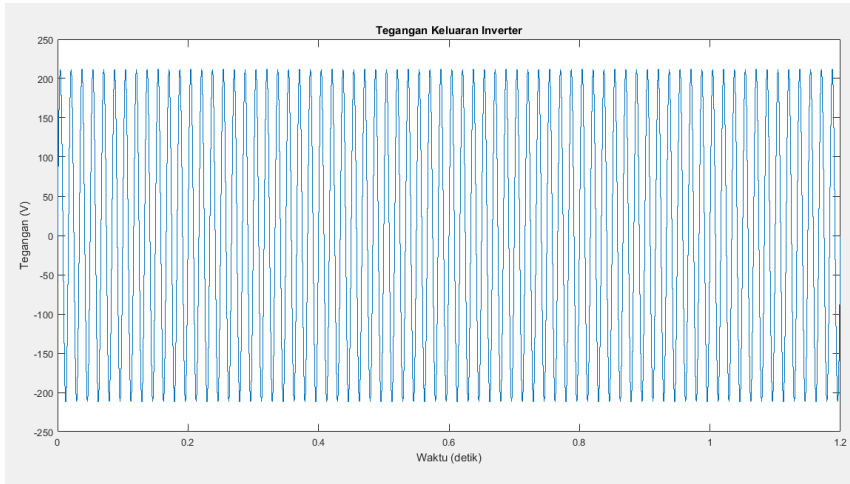

Fig. 12. Inverter output voltage.

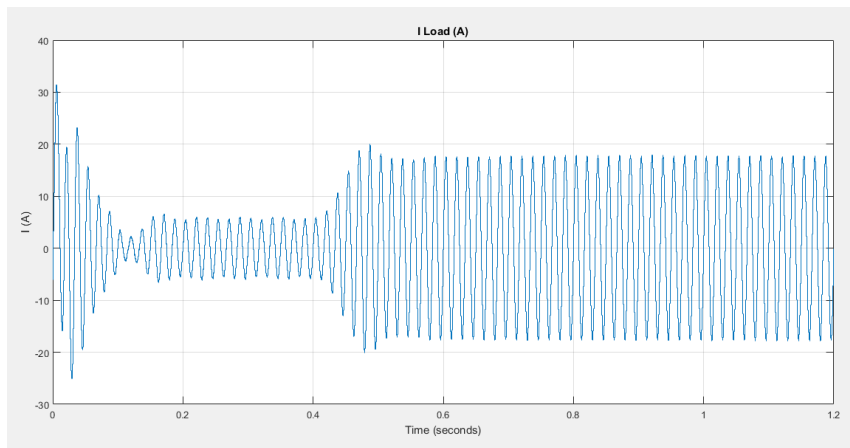

Fig. 13. Load current connected to the grid.

Figure 12 shows the output voltage generated by the inverter of 220 V AC. The resulting voltage is in sync with the utility grid voltage. While Figure 13 shows the load current, changes in load current occur from 0.18 seconds to 0.42 seconds.

6 Conclusions

In this research design, 1,500 watts of residential electrical power is used or an hourly energy consumption of 1.5 KWh, and this electrical load will turn on at 07.00 to 17.00. Therefore, for the electrical energy storage system used 3 12 Volt batteries with a capacity of 100 Ah each, and the power provided by the battery = 1800 watts. Because the power capacity used is 1,500 watts, this design uses 2 solar panels of 100 Wp (Watt peak) with an output voltage of 12 V DC. The output of 100 Wp solar panels is produced at a temperature of 25 C, a pressure of 1.5 atm, with a light intensity of 1000 W/m² is 2 units x 100 Wp = 200 Watts per one hour of heating at the peak of heating. In a day, approximately 200 Wp x 10 hours of electricity can be generated. Heating = 2,000 Wh. In the design of the simulation model, it can be seen that the use of fuzzy logic controller control in the boost converter is able to produce higher output power when compared to other control methods. In addition, the output

voltage overshoot is also lower. To determine the performance of the on-grid system, it can be developed using the PID-fuzzy algorithm, and implemented based on the simulation results using an FPGA or microcontroller. To overcome the limitations of solar energy when solar energy begins to fall after noon, it is recommended to use batteries as a backup energy source. Therefore, it is recommended that in residential homes, the use of PV can be used in two ways (standalone and grid connected) interchangeably.

We would like to thank the Kemdikbudristek for providing research funds and LPPM University of PGRI Semarang which has assisted in carrying out the research.

References

1. A. Kusmantor, M. Novita. "Use Of Inverter Off Grid 2000 Watt For Household With Battery Storage Use Of Inverter Off Grid 2000 Watt For Household With Battery Storage". *Journal of Physics: Conference Series*, Volume 1,179, pp.1-6 (2019)
2. A. Kusmantor, A. Priyadi, M.H. Purnomo. "Voltage Stability in DC Micro Grid By Controlling Two Battery Units With Hybrid Network Systems". 5th International Conference on Industrial Engineering and Applications, Singapore, pp.163-168 (2018)
3. D. M. Tobnaghi & R. Vafaei. "The Impacts of Grid-Connected Photovoltaic System on Distribution Networks - A Review". *ARNP Journal of Engineering and Applied Sciences*, Vol.11, No.5, pp.3564-3570 (2016)
4. B. Apurv & A. Ramprasad. "Design and Proposal of Solar Photovoltaic Power Plant For Medium Scale Industry". *International Journal of Advances in Scientific Research and Engineering*, Vol. 3, pp.11-12 (2017)
5. C. Jaisin, A. Intaniwet, T. Nilkhoa, T. Maneechukate & S. Mongkon. "A prototype of a low - cost solar - grid utility hybrid load sharing system for agricultural DC loads". *International Journal of Energy and Environmental Engineering*, Vol. 10, pp.137-145 (2019)
6. M. Premkumar, K. Karthick & R. Sowmya. "A Review on Solar PV Based Grid Connected Microinverter Control Schemes and Topologies". *Int. Journal of Renewable Energy Development*, pp.171-182, ISSN: 2252-4940 (2018)
7. R.R. Mojumdar, A.W. Bhuiyan & H. Kadir. "Design & Analysis of an Optimized Grid-tied PV System : Perspective Bangladesh". *IACSIT International Journal of Engineering and Technology*, Vol.3, No.4 (2011)
8. S. Wei, E. Temitope & N. Zealand. "Adoption of Solar Grid-Tied PV-System Adopted in a Residential Building". *Australasian Journal of Construction Economics and Building Conference Series 2*, pp.80-88 (2018)
9. M. Shahjehan, W. Shahjehan, M. Arbab, M. Shahjehan, W. Shahjehan, M. Arbab, M.N. Arbab. "Grid-Tied PV System with Energy Optimization". *International Journal of Engineering Works*, Vol. 4, Issue 10, pp. 184-189 (2017)
10. L.Fara & D. Craciunescu. "Output Analysis of Stand-Alone PV Systems: Modeling, Simulation and Control". *Energy Procedia*. EENVIRO, pp.595-605 (2017)
11. I, E. O. P., C, E. O. C., Obinna, E. O., O, E. M. D., & E.A. Uche. "Details of Photovoltaic Solar System Design Calculations and the Accessories". *International Journal for Research in Applied Science and Engineering Technology*, ISSN: 2321-9653, Volume 5 Issue VI, pp.2933-2938 (2017)
12. A.M. Humada, M. Hojabri, M. Herwan, B. Sulaiman, & H.M. Hamada. "Photovoltaic Grid-Connected Modeling and Characterization Based on Experimental Results". *journal.pone*, pp.1-13 (2016)

13. E.A. Egbivwie, V.O. Ughwumiakpor, & A.P. Ayinuola. "Computer Aided Off-Grid Solar PV System Design". *International Journal of Scientific and Research Publications*, Volume 7, Issue 9, ISSN 2250-3153, pp.310-317 (2017)
14. A.J. Mahdi. "Design and Performance Analysis of An On-Grid Photovoltaic Power System Under Iraqi Solar Circumstances". *Journal of Engineering and Sustainable Development*, Vol. 21, No. 04, pp.46-47 (2018)
15. I.M. Al-adwan. "Performance Assessment of the First Residential Grid-Tie PV System in Jordan". *Journal of Energy Technologies and Policy*, Vol.3, No.4, 2013. pp.7-10.
16. M.Namjoshi, Anubha. "Study of Grid tied Smart Solar Photovoltaic system: A review". *International Journal of Scientific & Engineering Research*, Volume 4, Issue 10, pp.811-815 (2013)
17. N.V. Eldhose & P.P. Joseph. "Design of an off Grid Photovoltaic system for New Office Buildings". *Journal of Electronics and Communication Engineering*, Volume 11, Issue 6, pp.53-57 (2016)
18. M.A. Omar & M.M. Mahmoud. "Design and Simulation of a PV System Operating in Grid-Connected and Stand-Alone Modes for Areas of Daily Grid Blackouts". *International Journal of Photoenergy*, pp.1-9 (2019)
19. A.A.E. Tawfiq, M.O.A. El-Raouf, M.I. Mosaad, A.F.A. Gawad, M.A.E. Farahat. Optimal reliability study of grid-connected PV systems using evolutionary computing techniques. *IEEE Access*. Vol.9, pp. 42125-42139 (2021)
20. K.M. Fetyan & R. Hady, "Performance evaluation of on-grid PV systems in Egypt", *Water Science*, Vol.35, pp.63-70 (2021)