

Enhancement DC Microgrid Power Stability With a Centralized

line 1: 1st Adhi Kusmantoro
line 2: department of electrical
engineering
line 3: Universitas PGRI Semarang
line 4: Semarang, Indonesia
line 5: adhiteknik@gmail.com

Abstract—The residential electricity load increases every year according to the increasing number of residents. But the utility grid that uses fossil sources has not been able to serve the increasing residential electricity load. In this study, a centralized DC microgrid method is proposed to supply residential premises. DC microgrid uses renewable energy sources. The method used is a centralized system with a battery unit storage system. The excess energy of each PV installed on the roof of the residence is stored in the battery. If one of the PVs in the residence is disconnected, the battery will supply energy to the residence. The results of the study show that the centralized load system only requires total load data, while in the distributed load system the battery is used to meet the peak load demand of each load. Therefore the cost of a distributed load system is much greater.

Keywords—Residential Load, Centralized System, Battery Unit, DC Microgrid

I. INTRODUCTION

At the present time, the interest in developing DC microgrids has increased, researchers have developed stability in microgrids. The stability of the microgrid is now a challenge for other researchers [1]. DC microgrid shows unique and different characteristics from other electric power systems. The problem of serving uninterrupted loads and the microgrid model is used a different approach to the conventional power system [2]. Grid DC continues to grow every year in accordance with the development of the generation system. DC sources derived from renewable energy have different characteristics. This DC source is now starting to be used for commercial, industrial and residential load needs. The DC microgrid model has been developed to meet the load requirements. DC microgrid with multiple distributed generating sources. To use the AC load in the housing, an inverter is used [3]. Proposed [4-5] AC/DC hybrid microgrid model using grid-connected and islanding operations. This model uses a PV source and a wind turbine. When connected to the grid, the control coordination serves to maintain a balance of power during operation. When islanding, the control coordination serves to stabilize the voltage. With this method a balance of AC and DC power sources can be achieved, so that the stability of the microgrid in supplying housing power is achieved.

Many countries are now promoting low energy and zero energy buildings. Cheap buildings can cover all local energy needs. Renewable energy sources for buildings are environmentally friendly. In a DC microgrid system, it

consists of DC loads, such as LED lights, computers, electric vehicles, and renewable energy sources (PV panels, wind turbines) [6]. Since renewable energy is changing all the time, a lot of research has been done on DC microgrids. DC microgrids are easier to integrate with distributed energy and storage systems. Therefore it is more suitable for building DC power distribution system than AC power distribution network. This study designed a microgrid with a 500 V DC bus with a 20 Kw PV source, battery storage, and DC load [7]. Fossil energy sources are depleting at an alarming rate every day, even close to zero. In addition, the pollution produced by this non-renewable energy has proven to be harmful to the lives of people on Earth. So it is very important to understand the importance of renewable energy or green energy in the current era of technological development. Therefore we need methods to reduce the use of non-renewable resources. The use of renewable energy sources does not have an environmental impact, because this energy is environmentally friendly. There are many renewable energies, such as solar energy and wind energy. Researchers have used this energy as a DC Microgrid source, as one of the Green Energy efforts [8]. The DC power distribution system enables operational optimization of the DC microgrid. The microgrid model is flexible and can be synchronized with other renewable energy sources. DC microgrid offers the possibility of implementing energy management systems taking into account fluctuations in energy prices and the availability of various energy sources [9].

DC microgrid is desirable to supply power to remote areas far from the main network. DC Microgrid uses renewable energy and creates an open horizontal environment for distributed interconnection power generation, in particular (PV). The stochastic nature of the PV. Output power produces large fluctuations in the microgrid DC power and voltage, so a regulator is required for voltage stability. This study uses a fuzzy-PID control strategy to regulate the microgrid DC bus voltage at the load of four residential houses [10-12]. This study [13] uses a small signal analysis model on a microgrid. Microgrid works islanding and tested based on time constant, droop control and changes in grid frequency parameters. The results of previous studies showed that the use of a high time constant and a droop constant could affect the stability of the microgrid. This study proposes Newton's algorithm method, for the islanding microgrid operation. This new method shows better stability than the previous method in microgrid operation. In the development of DC microgrid [14] three PV units are used, one PV unit consists of two PV modules. In the

microgrid design, two batteries are used, which are used to store PV output energy and a unidirectional source from the AC grid. The PV output voltage is 22.8 V DC and the battery output voltage is 22.78 V DC. In this microgrid, a boost converter is used to increase the output voltage by 48 V DC, this is the DC bus voltage. The method used is to increase the stability of the DC bus voltage, so that the voltage supplied to the housing remains stable. Voltage regulation using PID control. Another method used [15] to improve the stability of DC bus power is using Fuzzy-PID control. This is because the source of solar energy changes all the time and depends on weather conditions. Fuzzy-PID control method is used to increase the maximum power output on MPPT. With this method the stability of the DC bus power can be increased. Based on the research conducted, Fuzzy-PID control produces lower overshoot and rise time if PID control is used. The output power in residential can be increased by the coordination method of battery control [16-18], to supply power to the housing when the microgrid is islanding. It is an excellent solution for residential power requirements. This method can increase the load demand. To cope with changes in PV power, a battery (BESS) can be used. This research proposed a new AC coupling configuration. For battery control, fuzzy logic is used. The results showed that the battery control response, settling time and overshoot were lower when PI control was used. This indicates a faster battery response supplying power to the DC bus. The new configuration results in lower voltage and current THD.

Based on the achievements of the microgrid research described above, this study proposes a centralized DC microgrid configuration. This centralized configuration is used to supply a DC source to the residence. If each residence is overloaded, then the DC source is stored in the battery centrally. The energy stored in the battery is used to supply the load when the DC source at the residence is disconnected. In addition, when the PV output power is low, the battery will supply the load.

II. DC MICROGRID

A. Autonomous Control

In knowing the dynamic performance of a DC system, small signal modeling is used. In this model DC microgrid consists of two terminals, namely the power terminal and the slack terminal. Terminal slack settings greatly affect the dynamic performance of DC microgrids. This modeling uses virtual impedance method [19-20].

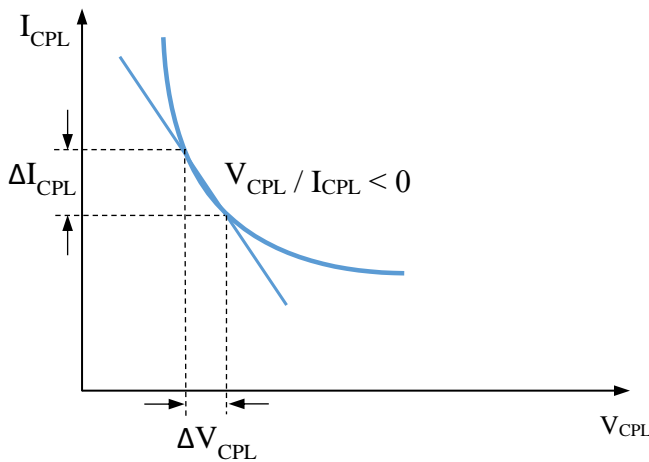

Fig. 1 CPL negative resistance.

The transfer function at the slack terminal can be expressed by the following equation

$$Reg(s) = Reg V(s) \times Reg I(s) \quad (2.1)$$

Droop control has been used in autonomous control systems, especially droop control with constant power load (CPL). The slack terminal will supply the CPL with a conductor resistance R_L , so that the voltage at the load terminal is:

$$V_{dc} = V_{ref} - (R_{eq} + R_L)I_{dc} \quad (2.2)$$

$$V_{dc} \cdot I_{dc} = konstan = P_L \quad (2.3)$$

Figure 1 shows the characteristics of CPL having a negative V-I curve slope. The resistance is always negative because $\Delta V_{CPL} / \Delta I_{CPL} < 0$. So the current through the CPL decreases as the voltage across it increases and vice versa.

B. Load Sharing

The purpose of load sharing in a DC microgrid is to share the load accordingly. Moreover it is used for the appropriate regulation of voltage and current from different sources. One of the load sharing is by dividing the current flowing from two or more DC micro grid sources [21-22]. The load current distribution is modeled by an equivalent circuit, which is shown in Figure 2.

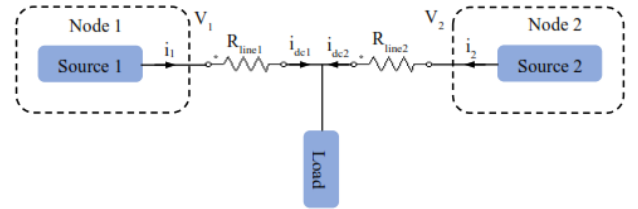

Fig. 2 Microgrid model with two sources.

The droop control used in the DC microgrid model is stated as follows

$$v_{sj} = v_s - i_{dcj}R_{dj} \quad (2.4)$$

The load stress equation can be expressed as follows

$$v_{load} = v_s - i_{dc1}R_{d1} - i_{dc1}R_{line1} \quad (2.5)$$

$$v_{load} = v_s - i_{dc2}R_{d2} - i_{dc2}R_{line2} \quad (2.6)$$

The equation can be simplified as follows

$$\frac{i_{dc1}}{i_{dc2}} = \frac{R_{d2}}{R_{d1}} + \frac{R_{line2} - \left(\frac{R_{d2}}{R_{d1}}\right)R_{line1}}{R_{d1} + R_{line1}} \quad (2.7)$$

If it is assumed that the DC microgrid is a small scale network and the R_{line} has a small resistance, then the virtual resistance R_{dj} can be chosen to be larger. Therefore equation (2.7) can be stated as follows

$$\frac{i_{dc1}}{i_{dc2}} = \frac{R_{d2} + R_{line2}}{R_{d1} + R_{line1}} \approx \frac{R_{d2}}{R_{d1}} \quad (2.8)$$

III. DC MICROGRID CENTRALIZED SYSTEM DESIGN

In this study, a centralized system configuration on a DC microgrid is used, for residential loads. In this study, four

residential loads were used with a battery storage system. In this off-grid system each residence consists of roof-mounted PV panels, linked together via a centralized battery bank. If there is excess power generated by PV, it will be stored in the battery. When the power generated by the PV is cut off, the battery will supply power to the load. The centralized method is shown in Figure 3. This figure shows a centralized microgrid, battery and load system configuration, consisting of multiple PV sources at separate locations connected via a DC Bus.

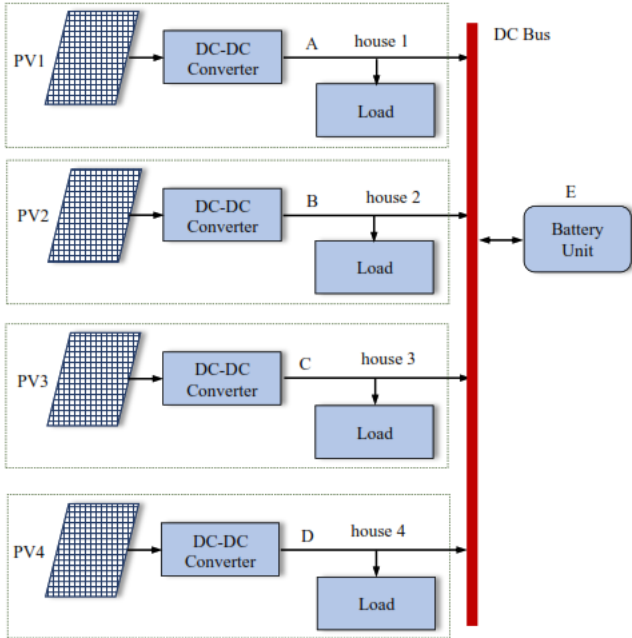

Fig. 3 Centralized system design.

Seen in the figure, all loads are connected centrally from each PV of the roof of the house. The excess power in the load will be stored in the battery pack. When the roof PV of the house no longer supplies power to the load, the battery unit will supply power to the load. Thus there will be an interaction of DC power from several DC sources, which results in a constant DC bus power. The battery pack in this configuration plays a major role in power management on the DC bus. Therefore, arrangements are made to control the DC bus power flow in the battery unit. In this configuration there are five nodes (node A, node B, node C, and node D, node E) each providing DC power to the DC bus. Nodes A through node B provide DC power to the DC bus with a solar source, while node E provides DC power when there is no solar energy.

IV. RESIDENTIAL LOAD

This study uses the load of four residential. Each residential has the same load profile. The load used is a DC load, which is shown in table 1.

TABLE I. LOAD DC

Load Type	Quantity	Working (hour)	Power (W)	Load (Wh)
LED	3	12	6	216
LED	5	12	10	600
CFL	4	6	20	480
Exhaust Fan	3	6	12	216
Computer	1	4	170	680
Water Pump	1	3	180	540
TV 40"	1	3	62	186
Solar Cooker	1	2	100	200

The table shows the name and number of loads, voltages and load power ratings. The lamp, solar cooker, and TV load in this micro grid system is a DC load in a residential.

In this study, the Solana SOL12-100 VRLA battery was used. The battery has the specifications shown in table 3.6. Based on the load profile data of a single residence, the total power usage for one day is 3,118 Wh or 259.83 Ah. Taking into account the 80% DOD (Depth of Discharge) of the battery, the battery capacity used is 80 Ah. Therefore, 4 batteries are used. These batteries are used for each dwelling in the distribution system, so the total number of batteries for 4 dwellings is 16 batteries.

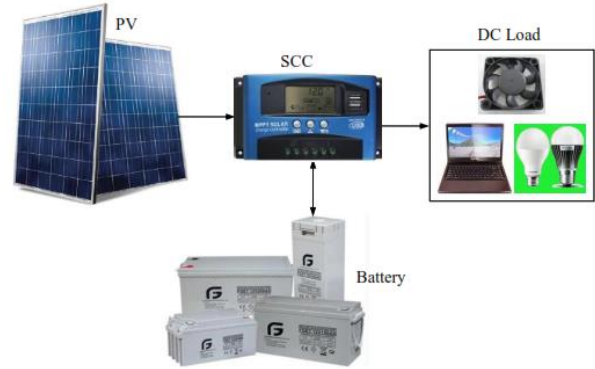

Fig. 4 PV configuration for one residential.

The total load in the microgrid system is the sum of the loads for each residential house, which can be expressed by the following equation

$$\sum_{j=1}^{n=4} P_{Lj}(t) = P_{L1}(t) + P_{L2}(t) + P_{L3}(t) + P_{L4}(t) \quad (3.1)$$

In a centralized system configuration, the battery unit used must be able to supply power according to the total load, which is 12,472 Wh or 1,039 Ah. Taking into account the 80% DOD of the battery, in a centralized system the number of battery units is 12 batteries. In the microgrid system, SCC (solar charge controller) is used as a DC-DC converter. SCC uses MPPT 40 A type with a maximum working voltage of 160 V DC. The PV output power is used to charge the battery via the SCC. The total power generated by PV in a micro grid system can be expressed by the following equation

$$P_{PV1}(t) = P_{PV1}(t) + P_{PV2}(t) + P_{PV3}(t) + P_{PV4}(t) \quad (3.2)$$

V. RESULTS AND DISCUSSION

In conducting microgrid research with an off-grid system carried out in the Semarang area, Ngaliyan sub-district, as shown in Figure 5. The location has a latitude of -7.00753° , a longitude of 110.35363° , an average temperature of 28.6° , and global radiation for one year. of 1748.3 Kwh/m^2 . The radiation intensity of the city of Semarang with a peak radiation of 402 W/m^2 occurs at 12.00, while the radiation intensity profile of the city of Semarang for one year is quite high. Therefore, the use of solar energy sources can be used in a centralized DC microgrid system. So that in this system, PV is used which is installed on the roof of each residence as an energy source on a DC microgrid which is very suitable for use. To overcome fluctuations in PV output, batteries are used according to the amount of load used. Each residence uses PV with the same amount and power capacity.

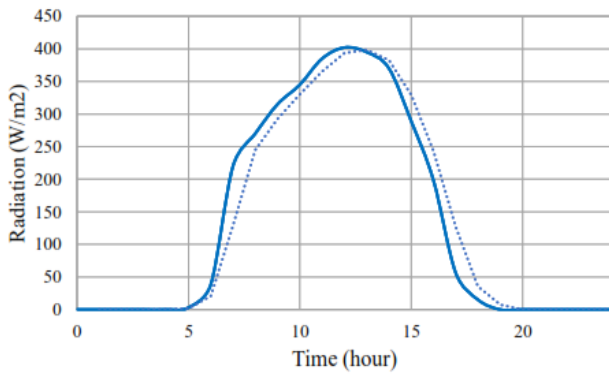

Fig. 5 Radiation profile of Semarang.

Figure 5 shows the energy use of a residential for one year, using PV*SOL software. The largest energy consumption occurred in January and December, while the lowest energy consumption occurred in June.

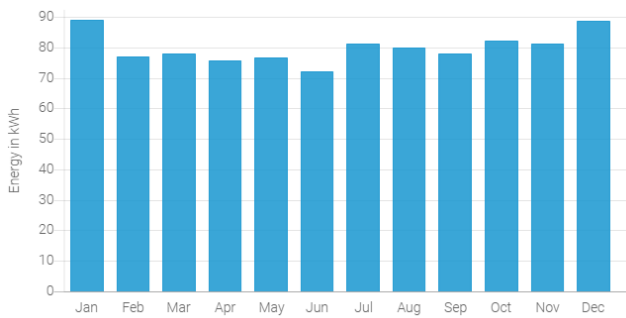

Fig. 6 Consumption of the load of one residential for one year.

While Figure 7 shows the energy produced by PV can meet the needs of the load, with a performance ratio of 79.98%. The greatest energy generated by PV occurs in October.

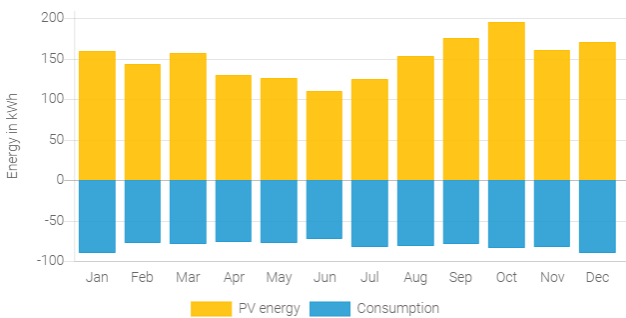

Fig. 7 PV energy and energy consumption of a single residential.

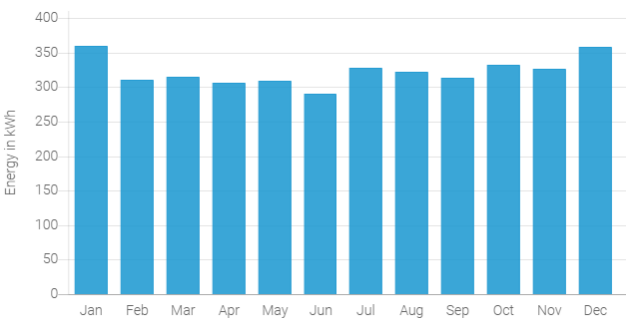

Fig. 8 Consumption of the load of four residential for one year.

Figures 8 and 9 show the energy consumption of four residential, the energy produced by PV can meet the needs of

the load. The largest energy generated by PV in October was 580 Kwh. When the energy generated by PV is higher than the load, the energy generated by PV will be stored in the battery. In this case the SOC of the battery has not reached its maximum.

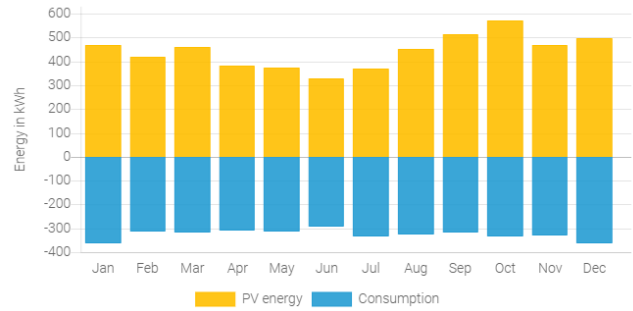

Fig. 9 PV energy and energy consumption of four residential.

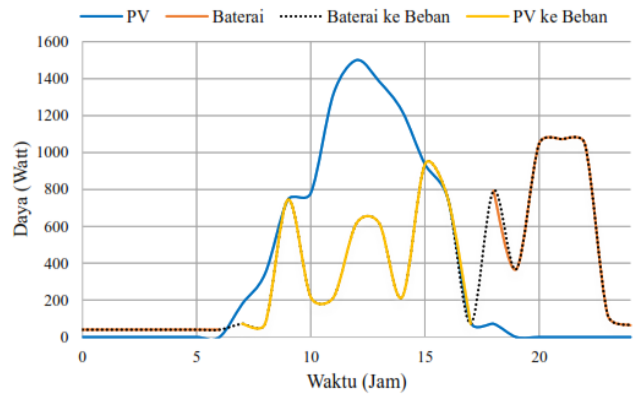

Fig. 10 Load and source graph of the four residential microgrid.

The power output from the PV node 1 to PV node 4 systems peaks during 09:00 to 15:00. After 15:00 to 17:00 the PV output power drops (blue graph). After 17:00 the PV output power is not sufficient to meet the load power requirements, so the battery supplies power to the load. In this case the battery contributes as an energy source to fill or reduce the supply and demand gap (black graph). From 18:00 to 06:00, the load depends on the battery capacity to meet the load's power requirements (orange graph).

VI. CONCLUSION

In an arrangement to control the flow of power separately to the DC bus, four nodes (node A, node B, node C, and node D) each supply the DC bus. Node A and node C provide DC power to the DC bus with solar power, node B and node D (battery source) provide DC power when there is no solar energy. The battery unit used for the centralized load system only requires total load data, while in the distributed load system the battery is used to meet the peak load demand of each load. Therefore the cost of a distributed load system is much greater. Using the centralized method is more effective in supplying the load when the PV source is disconnected

ACKNOWLEDGMENT

We would like to thank the Ministry of Education and Culture for providing financial support to carry out this research, so that we can participate in international conference. We also thank LPPM University of PGRI Semarang for their support, so that we can carry out seminars and all research activities.

REFERENCES

- [1] A. Hirsch, Y. Parag, J. Guerrero, Microgrids: a review of technologies, key drivers, and outstanding issues, *Renew. Sustain. Energy Rev.* 90 (2018) 402–411
- [2] M. Farrokhabadi, C. Canizares, J.W. Simpson-Porco, E. Nasr, L. Fan, P. MendozaAraya, R. Tonkoski, U. Tamrakar, N.D. Hatziaargyriou, D. Lagos, R.W. Wies, M. Paolone, M. Liserre, L. Meegahapola, M. Kabalan, A.H. Hajimiragha, D. Peralta, M. Elizondo, K.P. Schneider, F. Tuffner, J.T. Reilly, Microgrid stability definitions, analysis, and examples, *IEEE Trans. Power Syst.* Volume: 35, Issue: 1, Jan. 2020, 13-29.
- [3] A. Hirsch, Y. Parag, J. Guerrero, Microgrids: a review of technologies, key drivers, and outstanding issues, *Renew. Sustain. Energy Rev.* 90 (2018), pp. 402–411.
- [4] B. Liang , L. Kang , J. He , F. Zheng , Y. Xia , Z. Zhang , Z. Zhang , G. Liu , Y. Zhao, Coordination control of hybrid AC/DC microgrid, *The Journal of Engineering*, Vol. 2019 Iss. 16, pp. 3264-3269.
- [5] Eghtedarpour, N., Farjah, E.: ‘Power control and management in a hybrid AC/DC microgrid’, *IEEE Trans. Smart Grid*, 2014, 5, (3), pp. 1494–1505
- [6] T.T.H. Ma, H.Yahoui, H.G.Vu, N.Siauve and H.Morel, *Buildings* 2017, 7(2), 42, 1-12.
- [7] J.J. Justo, F. Mwasilu, J. Lee, J.W. Jung, AC-microgrids versus DC-microgrids with distributed energy resources: A review. *Renew. Sustain. Energy Rev.* 2013, 24, 387–405.
- [8] J.A.P. Lopes, A.G. Madureira, C.C.L.M. Moreira, A View of Microgrids, vol. 2, Wiley Interdiscip Rev: Energy Environ, 2013, pp. 86–103.
- [9] M. Yazdani, A. Mehrizi-Sani, Distributed control Techniques in Microgrids, *IEEE Transactions on Smart Grid*, 5, August 2014, pp. 2901–2909.
- [10] R. K. Chauhan; B. S. Rajpurohit; R. E. Hebner; S. N. Singh; F. M. G. Longatt, Design and Analysis of PID and Fuzzy-PID Controller for Voltage Control of DC Microgrid, 2015 IEEE Innovative Smart Grid Technologies - Asia (ISGT ASIA), 1-6.
- [11] R. K. Chauhan, B. S. Rajpurohit, “DC Distribution System for energy efficient buildings,” in *proc. 2014 IEEE 18th National Power System Conference*, India, Dec. 18-20, 2014, pp.1-6.
- [12] J. C. Choi, H. Y. Jeong, D. J. Won, S. J. Ahn and S. I. Moon, “Cooperative voltage control of distributed generation and grid connected converter in dc microgrid,” *Renewable Energy and Power Quality Journal*, no.2, Mar. 2013.
- [13] A. Garces, Small-signal stability in island residential microgrids considering droop controls and multiple scenarios of generation, *Electric Power Systems Research* 185 (2020), 1-12. Volume 185.
- [14] A.Kusmantoro, A.Priyadi, M.H.Purnomo, Voltage Stability in DC Micro Grid By Controlling Two Battery Units With Hybrid Network Systems, 5th International Conference on Industrial Engineering and Applications (ICIEA), April 2018, Singapura, 163-168.
- [15] A.Kusmantoro, A.Priyadi, V.L.B.Putri, M.H.Purnomo, Fuzzy-PID Controller On MPPT PV To Stabilize DC Bus Voltage, 2019 International Conference on Technologies and Policies in Electric Power & Energy, Yogyakarta, 1-6.
- [16] A.Kusmantoro, A.Priyadi, V.L.B.Putri, M.H.Purnomo, Coordinated Control of Battery Energy Storage System Based on Fuzzy Logic for Microgrid with Modified AC Coupling Configuration, *International Journal of Intelligent Engineering and Systems*, Vol.14, No.2, 2021. pp.495-510.
- [17] D.R. Aryani, and H. Son, “Coordination Control Strategy For AC/DC Hybrid Microgrids In Stand-Alone Mode”, *Energies*, Vol. 9, No. 6, pp. 1-20, 2016.
- [18] J. Xiao, S. Member, P. Wang, and S. Member, “Hierarchical Control of Hybrid Energy Storage System in DC Microgrids,” vol. 62, no. 8, pp. 4915–4924, 2015.
- [19] L.K. Letting, J.L. Munda, and Y. Hamam, “Dynamic Performance Analysis of an Integrated Wind-photovoltaic Microgrid with Storage,” *International Journal of Smart Grid and Clean Energy*, Vol. 3, No. 3, pp. 307-317, 2014.
- [20] D.Wu, F.Tang, T.Dragicevic, J.C. Vasquez, J.M. Guerrero, “Autonomous Active Power Control For Islanded AC Microgrids With Photovoltaic Generation and Energy Storage System”, *IEEE Transaction on Energy Conversion*, Vol. 9, No. 4, pp.882–892, 2014.
- [21] M. Rashad, U. Raouf, M. Ashraf, and B.A. Ahmed, “Proportional Load Sharing and Stability of DC Microgrid with Distributed Architecture Using SM Controller”, *Mathematical Problems in Engineering*, Vol. 1, No.1, pp. 1-16, 2018.
- [22] T. V. Vu, S. Paran, F. Diaz-Franco, T. El-Mezyani, and C. S. Edrington, “An alternative distributed control architecture for improvement in the transient response of DC microgrids,” *IEEE Transactions on Industrial Electronics*, vol. 64, no. 1, pp. 574–584, 2017.